

INSTRUCTION MANUAL

BUILT-IN ON-DEMAND
VACUUM SYSTEM

英語 / ENGLISH



R1A1(A)



CONTENTS

IMPORTANT SAFETY INSTRUCTIONS.....	1
NOMENCLATURE	4
TECHNICAL DATA	5
PREPARATION BEFORE USE	6
OPERATING THE AIR RIVETER	8
MAINTENANCE	9
TROUBLESHOOTING	16
EXPLODED VIEW.....	17
PARTS LIST	18
STORAGE	19
ORDERING PARTS	19

Professional model of air riveter to install blind rivets.

Thank you very much for purchasing “LOBSTER” air riveter.

To ensure correct operation, please read this instruction manual carefully, and keep it in a safe place for later reference.

In case you have some trouble and failure, please refer “Troubleshooting” in the Instruction Manual. Lobtex Co.,Ltd. has the copyright of this manual. It is prohibited to publish, copy or translate to other language without prior consent.

MANUFACTURER

LOBTEX CO.,LTD.

International Marketing & Sales Division

12-8 Shijo-cho, Higashi-Osaka City

Osaka 579-8053, Japan

Telephone: +81(72)981-7466

Telefacs: +81(72)981-9420

URL <https://www.lobtex.co.jp/>

● IMPORTANT SAFETY INSTRUCTIONS



- ◆ Be sure to read the following Important Safety Instructions carefully and make sure that you understand them thoroughly before using this tool.



- ◆ Always wear eye-protection at all times during use. If this is not observed, the cut mandrels may eject out when the rivets are cut and cause serious injury.



- ◆ This is the safety alert symbol. It is used to alert you to potential personal injury hazards. Obey all safety messages that follow this symbol to avoid possible injury or death.

- ◆ The Important Safety Instructions are divided into **⚠ WARNING** and **⚠ CAUTION**. The differences between these two levels are described below.

⚠ WARNING : Indicates a potentially hazardous situation which, if not avoided, could result in death or serious injury to the operator.

⚠ CAUTION : Indicates a potentially hazardous situation which, if not avoided, may result in moderate injury to the operator or physical damage.

Moreover, failure to follow the instructions marked with the **⚠ CAUTION** symbol or cautions without a **⚠ CAUTION** symbol which appear in the text of this manual may also have serious results in some cases. Always be sure to observe the instructions given in the Important Safety Instructions.

Note : Important note about the installation, handling and maintenance of this product.

- ◆ After reading this manual, keep it in a safe place where it is easily accessible to all users.

⚠ WARNING

- 1. The air pressure should be kept within the range of 0.5 to 0.6 MPa (71 to 85 psi).**
 - If an air pressure which is greater than this is used, the tool may become damaged, and injury or damage to property may result.
- 2. Never look into the nosepiece of the tool, and never point the nosepiece toward other persons.**
 - If the tool is used while the cut mandrels are still inside the tool not being ejected, these mandrels may be ejected from the tool's nosepiece during use and cause serious injury.
- 3. Always attach the tank case unit before use.**
 - If you work without attaching the tank case unit, there is a risk that the mandrel of rivet that has been cut is not discharged, and will be clogged inside exhaust pipe, causing a fault of the equipment. Also, these mandrels may be ejected from the tool's nosepiece during use and cause serious injury.
- 4. Wear protective glasses during use.**
 - Failure to do so may result in an accident or personal injury in case that a rivet or a piece of cut-mandrels jumps out toward you.
- 5. Make sure that the tool and the air source are connected securely.**
 - If the threads of the joints do not match or if the screws are not inserted far enough, the air hose may become disconnected during use and injury may result.
 - Use hose bands to securely connect the air hose joint and air hose. If they are not connected securely enough, the air hose may become disconnected during use and injury may result.
- 6. Turn off the air supply before disconnecting the tool from the air source.**
 - Compressed air may cause the air hose to whip around, and injury may result.
- 7. Check that all the tool parts are free from damage before use. Any damaged parts should be repaired before the tool is used.**
 - If the tool is used while any parts are still damaged, injury may result.
 - If the tool is damaged by objects being dropped onto it, for instance, the damaged part may break and accident or injury may result.
 - Don't pull and drag the tool by the air hose. It may trigger some damages on the tool body, breakage of Rotary Joint or some other defects and lead serious troubles with injuries.
- 8. If using in elevated locations, use a safety harness, and take care to avoid dropping rivets or the tool itself.**
 - Accident or injury may result if this practice is not followed.



CAUTION

- 1. Before starting maintenance or disassembling the unit to replace parts, be sure to stop air supply.**
 - Performing maintenance or disassembly with air supplied may cause a part to jump out, oil to squirt out, or the unit to perform unexpected behavior, and may result in an accident or personal injury.
- 2. Tighten the Bleed Plug firmly before use.**
 - If the Bleed Plug is loose or coming off during use, oil may squirt out resulting in an accident or personal injury.
- 3. Do not operate the tool with the Frame Head removed.**
 - Items such as fingers may become caught in the mechanism.
- 4. Do not bring your face close to the exhaust ports.**
 - Pressurized air containing fine particles is discharged from the exhaust ports during use. Keep eyes away from this area.
- 5. Avoid skin contact with substances such as hydraulic oil, lubricating oil and grease.**
 - Such substances may cause inflammation of the skin. If they come into contact with your skin, wash the affected area thoroughly.
- 6. The parts to be used must be those supplied from us or recommended by us. Select and attach parts applicable to your rivet.**
 - Otherwise the unit may not produce maximum performance and may sometimes malfunction resulting in an accident or personal injury.
- 7. Make sure that the workplace is safe, clean and organized.**
 - Accidents can easily occur in untidy workplaces.
 - If the cut mandrels are allowed to fall onto the floor, you may slip on them, and injury may result.
- 8. Avoid uncomfortable postures while working.**
 - You may fall down and injury may result.
- 9. Keep people who are not involved in work away from the workplace.**
 - Accidents or injury may result.
- 10. Maintain the tool with proper care.**
 - Refer to the Instruction Manual for details on replacing parts and attachments, otherwise injury may occur.
- 11. Keep the handgrip always dry and clean, and avoid adhesion of oil and grease.**
 - Otherwise the grip may slip from your hand resulting in falling of the unit.
- 12. Do not leave the floor littered with cut mandrels.**
 - Cut mandrels are dangerous because their ends are sharp. Stepping on them is also dangerous easily causing a slip and fall accident.
- 13. Use the tool carefully and concentrate on correct operation at all times.**
 - Use the tool with proper care, paying full attention to methods of handling and operation and surrounding conditions. Accidents and injury may result if this practice is not followed.
 - Use common sense at all times, otherwise accidents or injury may result.
 - When you are tired, do not use the tool, otherwise accidents or injury may result.
- 14. Ask Lobtex to carry out any repair work required.**
 - Repair work should only be carried out by a qualified technician. Please contact your nearest "LOBSTER" distributor, representative, or direct to Lobtex Co., Ltd., Osaka. If the tool is repaired by someone without the necessary qualifications and experience, the tool may not perform to optimum standards, and accidents or injury may result.
- 15. Do not attempt to modify the tool.**
 - Unauthorized modifications may cause malfunctions which can lead to accidents or injury.
- 16. Only for EU countries, do not dispose of electric tools together with household waste material!**
 - In observance of European Directive 2002/96/EC on waste electrical and electronic equipment and its implementation in accordance with national law, electric tools that have reached the end of their life must be collected separately and returned to an environmentally compatible recycling facility.
- 17. Important information and clue about the use are listed in main body label. When contents cannot read by contamination or by the damage of the label, please order a new label and put it.**
 - The new label could be ordered from us(Lobtex)via distributor.

⚠ CAUTION

18. The production date of this product is shown brevity code below the tools.(on page5)

(Example) year: 2 0 1④ month:⑧ → N Y

How to check manufactured date

N Y

A year/month of manufacture	A	B	M	N	K	W	T	Y	U	O	L	Z
An English character	1	2	3	4	5	6	7	8	9	10	11	12

19. This product is a tool for exclusive use of the professional business. When you are the one who uses this tools for the first time, please receive an instruction from the one who have already used this tools before, also please read the Instruction Manual carefully and understand the content.
- Wear protective goggles or safety glasses.
 - When this product is damaged, please do not use.
20. This product is an exclusive tool for Blind Rivet fastening two boards by riveting. We do not design, manufacture or sell intending to other applications.
21. For the maintenance of the main body, for every 30,000 installation of the fastener or in one year.
22. Only qualified and trained operators should install, adjust or use the assembly power tool for non-threaded mechanical fasteners.
23. Slips, trips and falls are major causes of workplace injury. Be aware of slippery surfaces caused by use of the tool and also of trip hazards caused by the air line or hydraulic hose.
24. Proceed with care in unfamiliar surroundings. There can be hidden hazards, such as electricity or other utility lines.
- You may fall down and injury may result.
25. This assembly power tool is not intended for use in potentially explosive atmospheres.
26. This assembly power tool is not insulated against contact with electric power.
27. Ensure that there are no electrical cables, gas pipes, etc.,which can cause a hazard if damaged by use of the tool.
28. If you experience numbness, tingling, pain or whitening of the skin in your fingers or hands, stop using the assembly power tool, tell your employer and consult a physician.
29. Air under pressure can cause severe injury.
- Always shut off air supply, drain hose of air pressure and disconnect tool from air supply when not in use, before changing accessories or when making repairs.
 - Never direct air at yourself or anyone else.
30. Always check for damaged or loose hoses and fittings.
- Whipping hoses can cause severe injury.
31. Handle this product in a careful manner.
- Rough handling may cause an accident and failure of the tool. Do not throw, drop, nor give shock to this product.
32. Do not carry nor trail this product by pulling a joint hose.
- It may cause a damage to the hose, a failure and an abnormal action of this product. Then, an accident and injury may result.
33. The regular preventative maintenance shall be carried out, for instance after a specified time of operation, a specified number of cycles/operations or a stated number of times per year.
34. When you handle hydraulic oil or grease, obtain the Safety Data Sheet (SDS) from the supplier, and follow the described instructions.
35. When disposing this tool, please follow the regulations and the rules of the country and autonomous community.



● NOMENCLATURE

英語 / ENGLISH

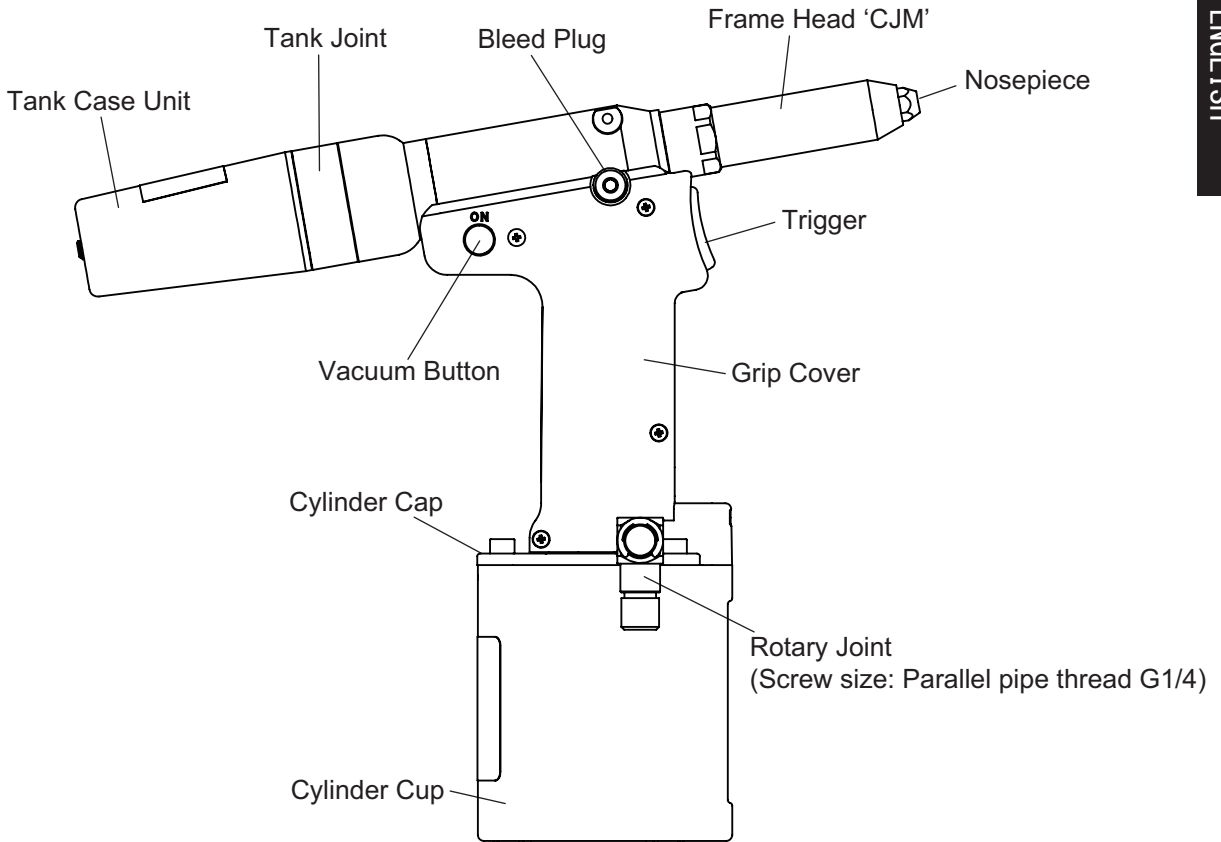

FRAME HEAD INTERNAL PARTS

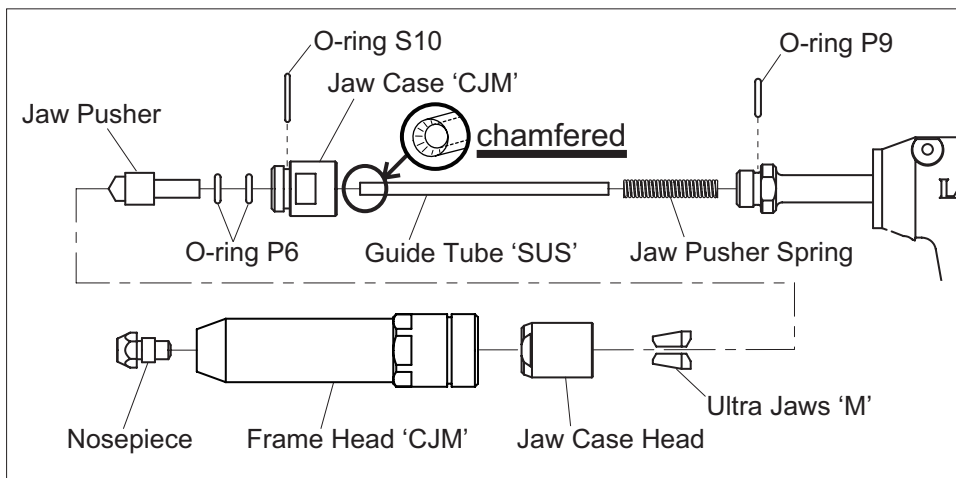

● TECHNICAL DATA

Model No.		R1A1 (A)
Weight	kg (lbs)	1.1 (2.43)
Operating air pressure		0.5 ~ 0.6 MPa (71 ~ 85 psi.)
Dimensions (Length × Height × Width) mm		297 × 265 × 106
Air consumption per minute	L (cu.ft.)	68 (2.4) (on the occasion of vacuum is working.)
Tool stroke		19 (3/4)
Traction power at 0.59 MPa		9.0
Applicable rivets (rivet diameters)	φ mm	2.4, 3.2, 4.0, 4.8
	φ inch	3/32, 1/8, 5/32, 3/16
Operating environment	Temperature	4°C to 35°C
	Relative humidity	80%RH max. (No condensation)
Sound	Pressure level (Lpa)	73 dB
Vibration	Emission value	Less than equal to 2.5m/sec ²
Air intake (Rotary joint)		Size of screw G1/4 (PF1/4)

- Note**
- Product specifications and design are subject to change for improvement without notice.
 - Weight and dimensions given are standard values. Actual products may differ slightly from the values given.
 - The warning label is located on the side of the main unic Cylinder Cup.
 - The production date of this product is indicated on the top surface of Cylinder Cap with brevity code. Please refer to the page 3 how to read its brevity code.
 - The serial number of this product is indicated on the top surface of Cylinder Cap with numbers.

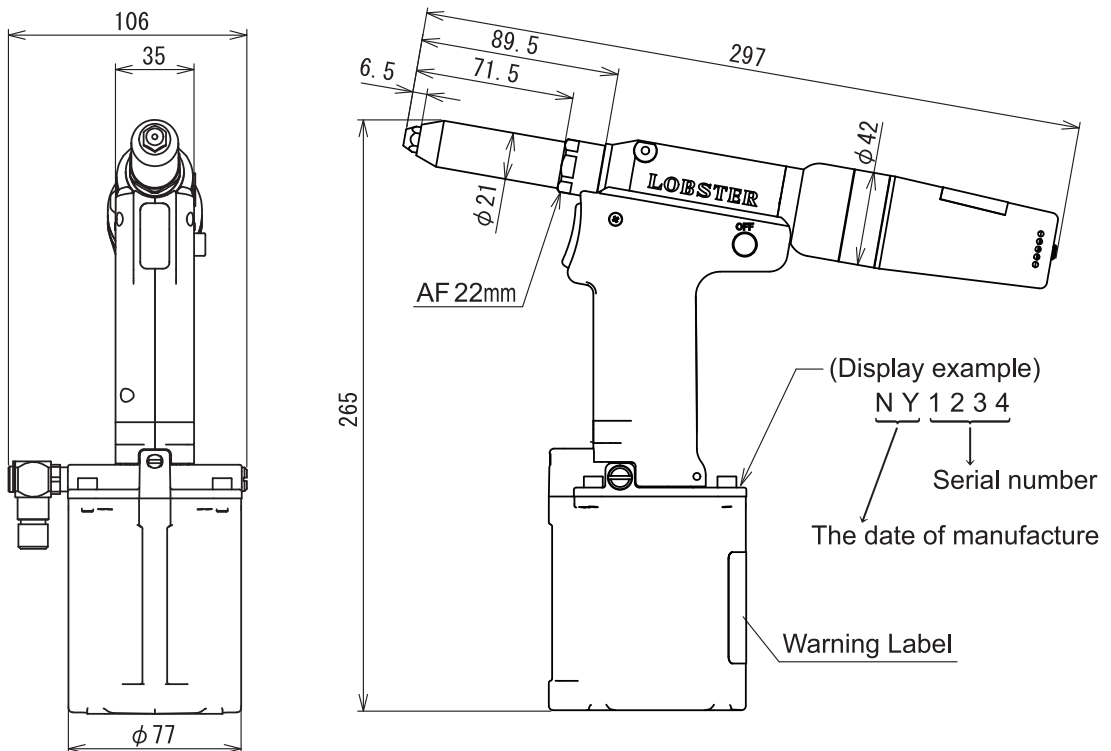

- Note** Air consumption calculation method
 Use the following calculation method to obtain the required air consumption, and select the compressor accordingly.

$$\text{Required air consumption} = \text{Air consumption per minute}$$

Make sure that this corresponds to the compressor discharge capacity (per minute).

● PREPARATION BEFORE USE



1 Set the Tank Case Unit to the Tank Joint.

⚠ WARNING

● Always attach the tank case unit before use.

If you work without attaching the tank case unit, there is a risk that the mandrel of rivet that has been cut is not discharged, and will be clogged inside exhaust pipe, causing a fault of the equipment. Also, these mandrels may be ejected from the tool's nosepiece during use and cause serious injury.

Push to fit the Tank Case Unit to the Tank Joint as shown in the figure, and turn the Tank Case Unit to the right until it is firmly fixed.

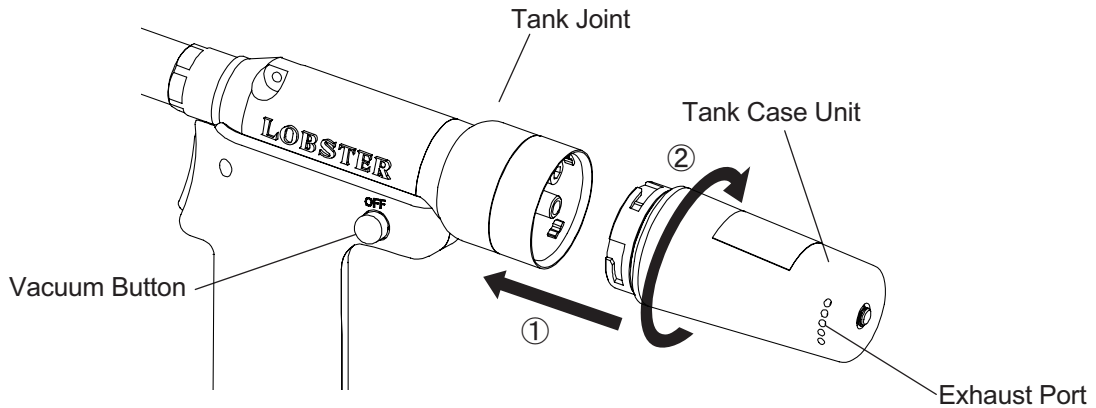

- Note**
- When you turn the Vacuum Button ON, air comes out of the Exhaust Port on the side of the Tank Case Unit.
 - The Exhaust Port can face to any of the 4 directions, so change the direction as your preference.

2 Set up the compressor, and be sure to install an air filter, air regulator and air lubricator (3-device set) between the compressor and the tool.

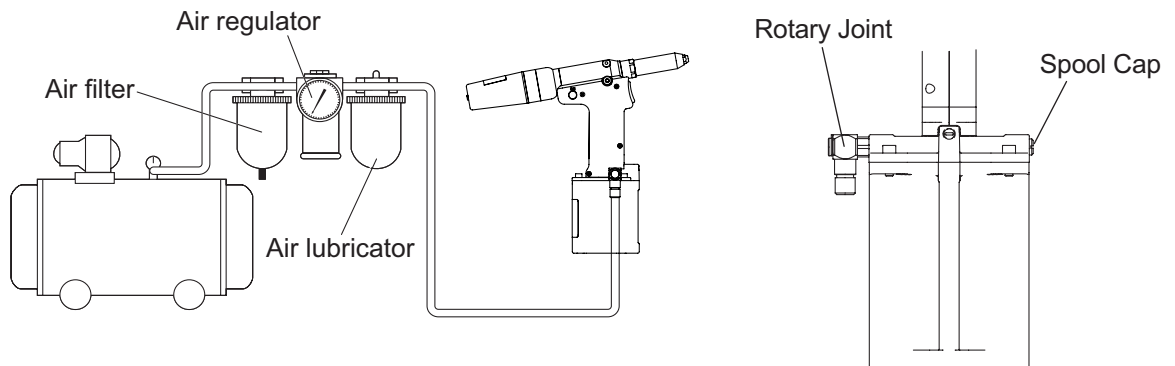

- Note**
- Adjust the drip-feed amount of the air lubricator to the minimum setting.
 - If moisture enters inside of the unit, it may freeze in cold temperature or accelerate degradation of O-rings and packings, resulting in malfunction of the unit. To avoid that, use an air dryer as necessary in addition to an air filter, regulator and an air lubricator (3-device set).
 - If you attach the Rotary Joint to the opposite side, remove the Spool Cap and exchange the positions.

3 Use the air regulator to adjust the operating air pressure to 0.5~0.6MPa (71~87psi).

⚠ WARNING





- The air pressure should be kept within the range of 0.5 to 0.6 MPa (71 to 87 psi). If an air pressure which is greater than this is used, the tool may become damaged, and injury or damage to property may result.

- Note**
- If the diameter of your stainless rivet (NST, NSS) is 4.8mm(3/16"), set the air pressure to 0.54 ~ 0.6 MPa (78 ~ 87 psi).
 - If the air pressure is too high, damage to parts may occur. If the pressure is too low, some size of the rivet may not be correctly installed (cut).

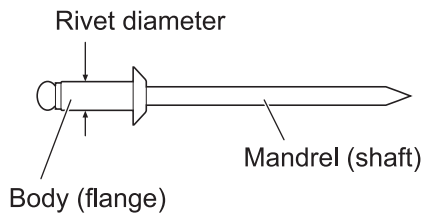
4 Replace the nosepiece and guide tube as indicated below to conform to the size of the rivet being used.

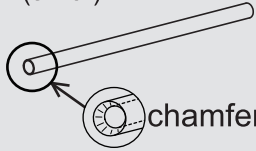
- Note**
- Refer to "Jaw maintenance" on page 9 for details on replacing the guide tube.



Rivet Dia.	Nosepiece	Guide Tube
2.4 mm (3/32")	2.4 	 Guide Tube 'SUS' (silver) chamfered
3.2 mm (1/8")	3.2 	
4.0 mm (5/32")	4.0 	A Guide Tube is not necessary for 4.0mm and 4.8mm rivets. Be sure to remove the Guide Tube before use.
4.8 mm (3/16")	4.8 	

- Note**
- Shaded areas indicate parts which are installed in the tool as standard accessories.
 - Conform the size to be used, and replace the nose piece with the corresponding one. If you use the Nosepiece improperly, cut mandrels may not be ejected normally after fixing and may clog inside or come up to the surface. That may also badly affect finishing of rivets. To avoid that, be sure to use an appropriate Nosepiece.
 - Applicable rivet size is marked on the hexagon part of Nosepiece.
 - A Guide Tube is not necessary for 4.0mm and 4.8mm rivets. Be sure to remove the Guide Tube before use.

● OPERATING THE AIR RIVETER



1 Select a suitable size of rivet for the workpiece to be riveted.

2 Replace the nosepiece with one which matches the size of the rivet to be used.
(Refer to item **4**) in "Preparation Before Use" on page 7.)

3 Drill a hole of appropriate size (0.1 to 0.2mm larger than the diameter of the rivet) into the workpiece.

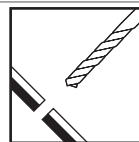

4 (1) Make sure that the Tank Case Unit is set, and press the Vacuum Button fully from the "ON" marking side to start vacuuming.
(2) Insert the mandrel of rivet into the end of riveter.

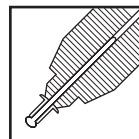

Note ● Some rivets have mandrels with sharp ends. Be careful not to injure your fingers on these ends.
● If the button is not fully pressed, vacuuming power will be lower.

5 After inserting the mandrel (shaft) of the rivet into the nosepiece, insert the head of the rivet into the hole.

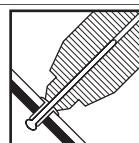

6 Lightly fit the end of riveting tool to the base material. Make sure that there is no space in the base material and other things, and then activate the trigger.

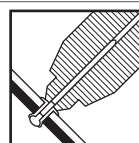

Note ● At the time and during activation of the trigger, a small amount of air may leak from the trigger portion. This is not a malfunction.

7 The rivet will be installed into the workpiece.

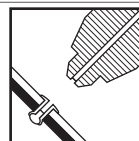

8 Release the trigger. The cut mandrel (shaft) will then be drawn into the tank case unit.

⚠ WARNING

● Always attach the tank case unit before use.
There is a risk that the spent mandrel will be clogged inside, causing a fault of the equipment.

Note ● Make sure that the cut mandrel has been completely removed before proceeding to the next riveting.

9 When the tank is about half full with cut mandrels, remove the Tank Case Unit by turning it to the left after stopping vacuum function, and discard the cut mandrels collected inside.

Note ● If the tank becomes over half full, cut mandrels may be obstructed by those inside the tank and may not normally be collected, causing them to be left in the ejection pathway. That will result in clogging of cut mandrels and air leakage from the Nosepiece making the unit to be unusable.

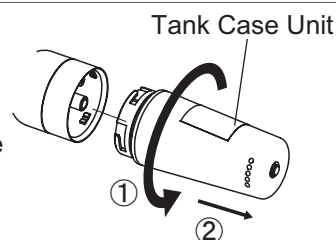

Note < Operating temperature > The ambient temperature for working is within the range of 4~35°C (39.2~95°F). Although condensation may occur on the lower part of Grip Cover depending on the number of rivets used, and the usage environment, that does not indicate a defect. Wipe off around the part before using the unit.

● MAINTENANCE

After long periods of use, debris from cut mandrels and other foreign materials tend to build up in various parts of the tool, and the hydraulic oil level also drops, both of which can lead to operating problems. The tool should be cleaned periodically.

Note ● In case you have some trouble and failure, please refer “Troubleshooting” in the Instruction Manual.

1 Jaw maintenance

Also refer to this section when replacing parts.

Note ● If debris builds up, the jaws will not move smoothly and normal operation will not be possible.
● The jaws should be cleaned on average once every 3,000 riveting operations.

⚠ CAUTION

● **Before starting maintenance or disassembling the unit to replace parts, be sure to stop air supply.**

Performing maintenance or disassembly with air supplied may cause a part to jump out, oil to squirt out, or the unit to perform unexpected behavior, and may result in an accident or personal injury.

● **Do not operate the tool with the Frame Head ‘CJM’ removed.**
Items such as fingers may become caught in the mechanism.

DISASSEMBLY

- 1 Turn off the air supply.
- 2 Remove the Frame Head ‘CJM’ using a wrench or spanner (AF22 mm).
- 3 Loosen and remove the Jaw Case Head and Jaw Case ‘CJM’ using spanners (AF14 mm and AF15 mm) or other tools. The following parts will be removed.

- Ultra Jaws ‘M’
- Jaw Pusher (With two O-ring P6)
- Jaw Case ‘CJM’ (With O-ring S10)
- Guide Tube ‘SUS’
- Jaw Pusher Spring

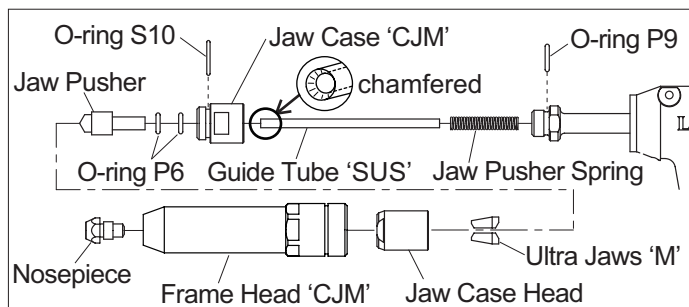
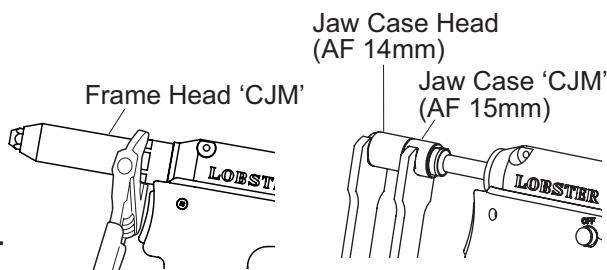

CLEANING

- 4 Wash and clean the parts using a brush and kerosene or such other things.

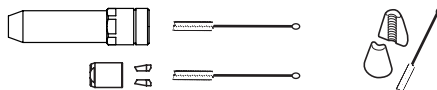

RE-ASSEMBLY

- 5 Assemble the parts in reverse order of disassembly and fully tighten the Jaw Case Head. In the end, attach the Frame Head ‘CJM’.

- Note**
- Apply LOBSTER lubricant oil JO-50 (separately sold: ISO VG150 containing molybdenum disulfide) to the back of Jaws or the inside of Jaw Case Head.
 - Assembling the Guide Tube will be smoother if you turn and insert the Guide Tube.
 - Be sure to assemble all of the parts and fasten the fastening sections firmly.
 - Jaw Case Head, Ultra Jaws ‘M’, Jaw Pusher, O-ring, Jaw Case ‘CJM’, Guide Tube, and Jaw Pusher Spring are consumable items. Replace them on a regular base.
 - Please check periodically whether there is any slack of the Frame Head ‘CJM’ during work. If you work after the Frame Head ‘CJM’ is loosened, damage to the parts may occur.
 - R1A1 is installed highly durable Ultra Jaws ‘M’.
- Be sure to specify Ultra jaws ‘M’ as replacement parts for this model.

◀ Jaw Case Head (Cross section) ▶

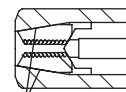

Apply jaw lube (lubricating oil)

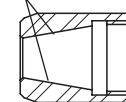

Label of reminder to securely tighten

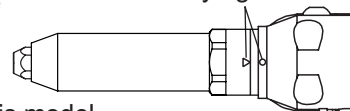



2 Replacement of the Nosepiece

- Note**
- If the Nosepiece is damaged, replace it with a new one.
 - If you change the rivet size, replace with an applicable Nosepiece.

⚠ CAUTION

- **Before starting maintenance or disassembling the unit to replace parts, be sure to stop air supply.**
Performing maintenance or disassembly with air supplied may cause a part to jump out, oil to squirt out, or the unit to perform unexpected behavior, and may result in an accident or personal injury.

DISASSEMBLY

- 1 Turn off air supply.
- 2 Remove the Nosepiece from the Frame Head 'CJM' using a wrench or spanner.

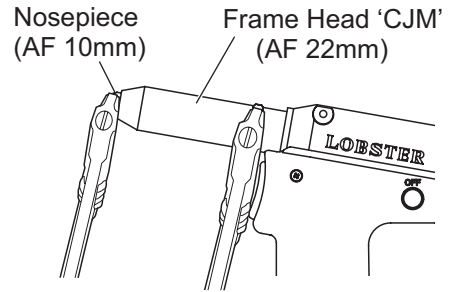

RE-ASSEMBLY

- 3 Firmly set a Nosepiece applicable to the rivet size to the Frame Head 'CJM'.

- Note**
- Please check periodically whether there is any slack of a nosepiece during work.
 - If you work after the nosepiece is loosened, damage to the parts may occur.

3 Replacement of the Tank Case Sponge

- Note**
- If power of vacuuming rivets becomes lower or the tank case sponge is damaged, replace with a new tank case sponge.

⚠ CAUTION

- **Before starting maintenance or disassembling the unit to replace parts, be sure to stop air supply.**
Performing maintenance or disassembly with air supplied may cause a part to jump out, oil to squirt out, or the unit to perform unexpected behavior, and may result in an accident or personal injury.

DISASSEMBLY

- 1 Turn off air supply.
- 2 Remove the Tank Case Unit by turning it in a counterclockwise direction.
- 3 Remove the Tank Case Sponge in the direction of the arrow.

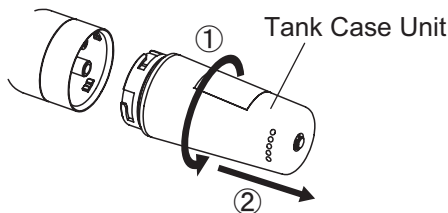

〈 Cross-section view of Tank Case Unit 〉

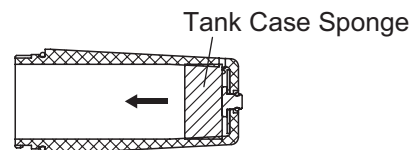

RE-ASSEMBLY

- 4 Assemble the tank case sponge and Tank Case Unit in reverse order of disassembly.

- Note**
- Tank case sponge is a consumable item. Replace it on a regular base.

英語 / ENGLISH

4 Cleaning and Oil Supply of Air Cylinder section

- Note**
- Accumulated dusts in the Air Cylinder section will adversely affect smoothness and durability.
 - If hydraulic oil becomes less causes insufficient stroke, supply hydraulic oil in the following procedure. If stroke becomes insufficient soon after supplying hydraulic oil, the cause may be abrasion of seal. In that case, please ask it for repair.

⚠ CAUTION

- **Before starting maintenance or disassembling the unit to replace parts, be sure to stop air supply.**
Performing maintenance or disassembly with air supplied may cause a part to jump out, oil to squirt out, or the unit to perform unexpected behavior, and may result in an accident or personal injury.
- **Avoid skin contact with substances such as hydraulic oil, lubricating oil and grease.**
Such substances may cause inflammation of the skin. If they come into contact with your skin, wash the affected area thoroughly.

DISASSEMBL

- 1 Turn off air supply.
- 2 Remove the Frame Head 'CJM' using a wrench or spanner (AF22mm).
- 3 Using a hex key wrench (AF 4mm) remove the 4 hex socket screws on the top surface of Cylinder Cap.
- 4 Turn the unit and keep it straight up as the Cylinder Cup comes to the top, and pull out the Cylinder Cup upward.
- 5 Pull out the Air Piston Unit upward.

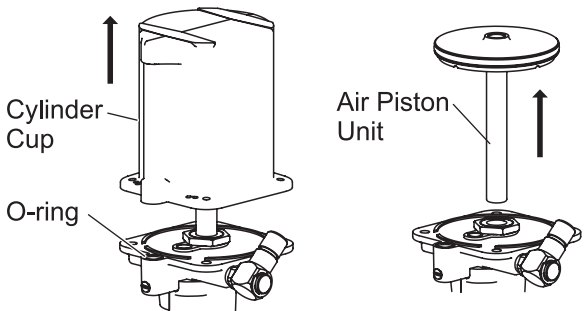
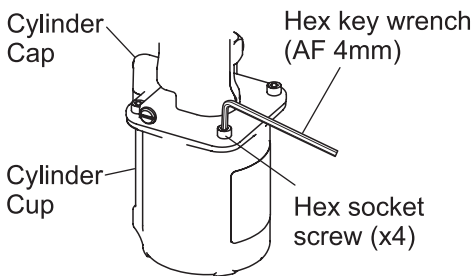

- Note**
- Keep the Frame Head 'CJM' removed during work. Otherwise the position of Oil Piston become too low due to excess oil, then, the parts may break.
 - Tilting the main body may cause the hydraulic oil to spill out. Keep it standing up during work.

CLEANING

- 6 Clean each part using a waste cloth and brush.

FILLING OIL

- 7 Supply LOBSTER hydraulic oil (B10012 : separately sold) from the oil supply port of Cylinder Cap until the oil comes to a bit upper line from O-ring of Frame A.

- Note**
- Keep the Frame Head 'CJM' removed during work.
 - Hydraulic oil used (viscosity) — ISO VG46

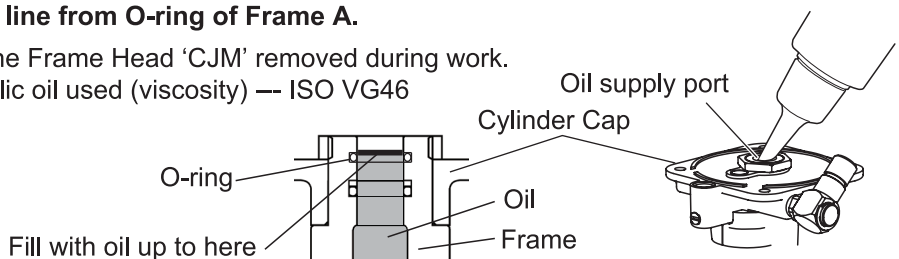



⚠ CAUTION

- **Avoid skin contact with substances such as hydraulic oil, lubricating oil and grease.** Such substances may cause inflammation of the skin. If they come into contact with your skin, wash the affected area thoroughly.
- **Maintain the tool with due care.** Refer to the Instruction Manual for details on replacing parts and attachments, otherwise injury may occur.

8 Apply grease to the O-Ring and rod of Air Piston Unit and to the inside of Cylinder Cup using brush.

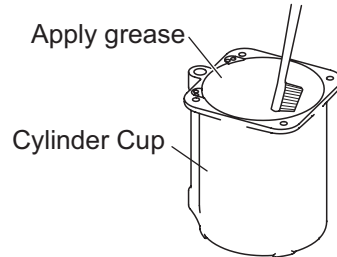
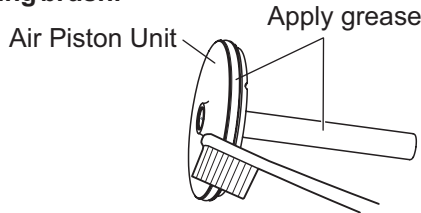

- Note**
- Before assembling, be sure to apply lubricant such as grease to each sliding section.
 - Recommended grease is Grease grade 1~2.

9 Push and insert the Air Piston Unit into the oil supply port and manually perform a piston motion for several times. Wipe off hydraulic oil spilling out of the oil supply port.

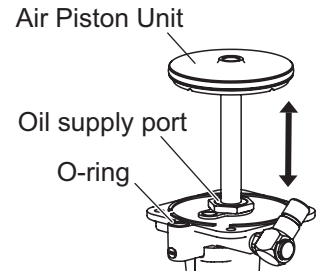

10 Attach the Cylinder Cup on the Air Piston Unit, and keeping pressing it down tighten the 4 hex socket screws.

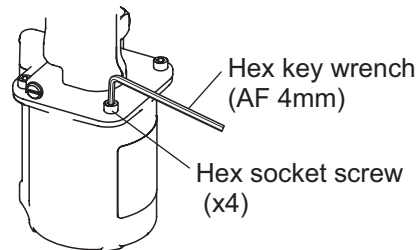
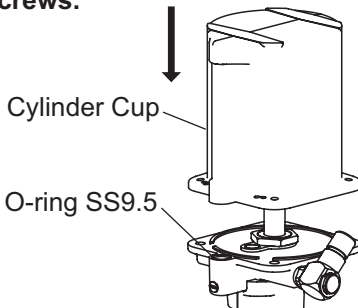

- Note**
- Assemble in reverse order of disassembly.
 - Make sure the O-ring SS9.5 is surely set in the counterbore.

11 After assembled Frame Head with Frame A, turn the unit as the Bleed Plug (hex socket bolt) comes to the upper side. Then, loosen it using a hex key wrench (AF 4mm) in order to let excessive hydraulic oil and air (bubble) out. After making sure that hydraulic oil no longer comes out, tighten the Bleed Plug again.

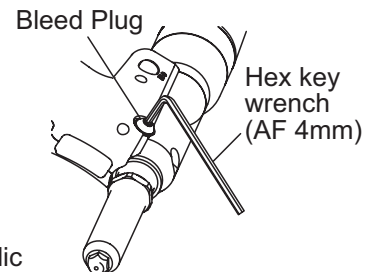

- Note**
- Note that hydraulic oil may squirt out when you loosen the Bleed Plug.
 - The work should be done by necessity after feeding hydraulic oil. Otherwise there may be detrimental to the tool in loading rivet or breakage of Frame.

12 Wipe off hydraulic oil adhering to the main body or spilling out before use.

- Note**
- During disassembly/assembly, be careful to prevent cutting dusts of metal and other objects from getting into the hydraulic oil and Air Cylinder.

5 Cleaning and Oil Supply of Air Valve

Note ● If the Air Valve is clogged with cut swarf, it has adverse influence on smooth operation and durability.

⚠ CAUTION

- **Before starting maintenance or disassembling the unit to replace parts, be sure to stop air supply.**
Performing maintenance or disassembly with air supplied may cause a part to jump out, oil to squirt out, or the unit to perform unexpected behavior, and may result in an accident or personal injury.
- **Avoid skin contact with substances such as hydraulic oil, lubricating oil and grease.**
Such substances may cause inflammation of the skin. If they come into contact with your skin, wash the affected area thoroughly.

- 1 Turn off the air supply.**
- 2 Remove cross recessed pan head screws (2 pieces) and tapping screws (3 pieces) on the side of the Grip Cover by using a Phillips screwdriver.**
- 3 Remove the Grip Cover, Trigger, Switch, and Silencer Sponge in this sequence.**

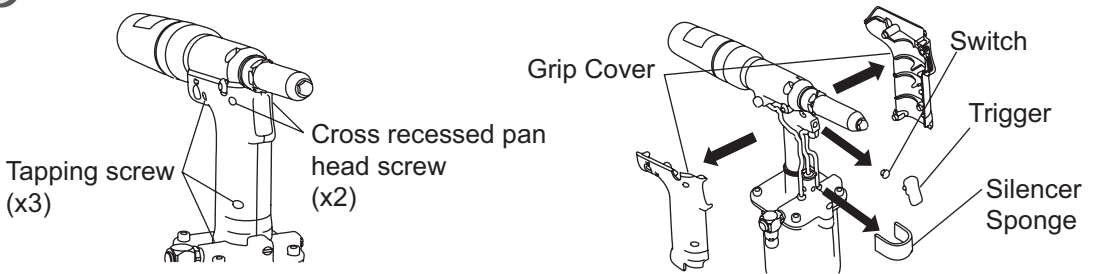

- 4 While moving the Urethane Tube forward by pushing it with a finger, remove the Air Valve Head Lock Plate by using pliers, etc.**

Note ● Also, if the Air Valve Head Lock Plate is mounted in the direction opposite to that in the figure below, push the tube to move it aside in the same manner, and remove the plate by using pliers, etc.

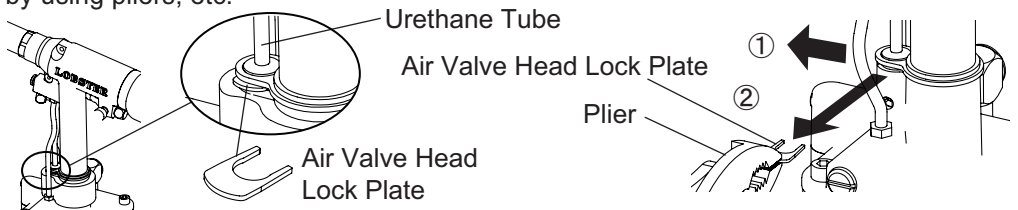

- 5 Remove the Air Valve Head, and pass a wire that has been bent like a hook through the exhaust port to raise the Air Valve to remove it.**

Note ● When removing the Air Valve, be careful not to damage the O-ring with the wire.

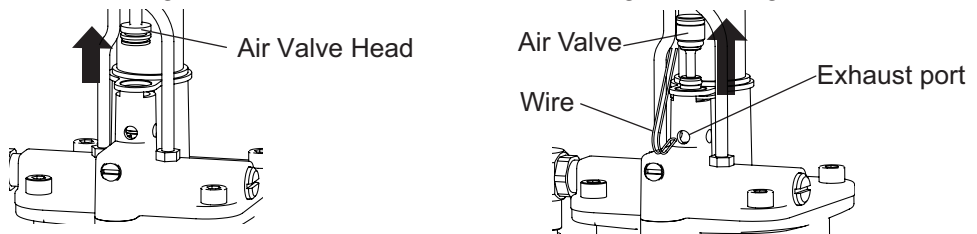

- 6 Apply grease to the O-ring of the Air Valve.**

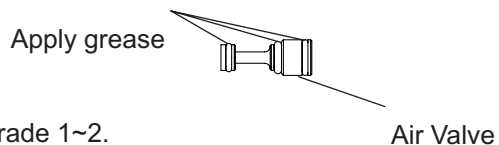

Note ● Recommended grease is Grease grade 1~2.

DISASSEMBLY

RE-ASSEMBLY

英語/ENGLISH



7 Attach the Air Valve and the Air Valve Head, and mount the Air Valve Head Lock Plate to the body by pinching it with pliers, etc.

- Note**
- Push the Air Valve Head securely to the end.
 - When mounting the Air Valve Head Lock Plate, move the Urethane Tube aside by pushing it with a finger.

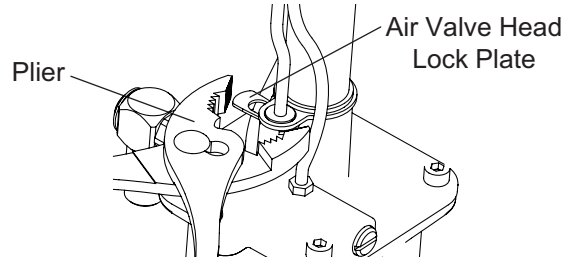
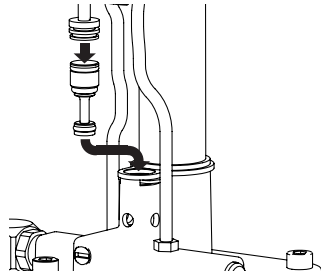

8 Mount the parts to the frame by following the procedure of 3) in reverse, and tighten the cross recessed pan head screws and the tapping screws by using a Phillips screwdriver.

- Note**
- Attach the Grip Cover with the Silencer Sponge around the body.

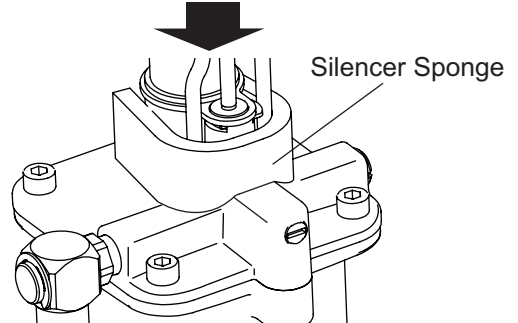
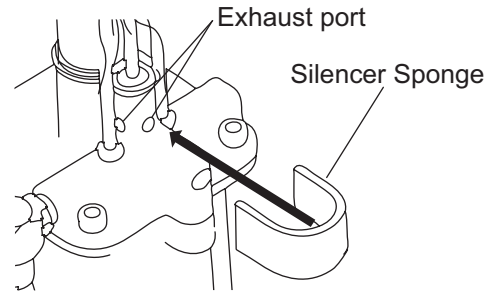
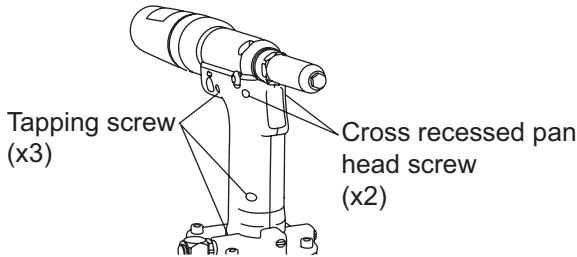
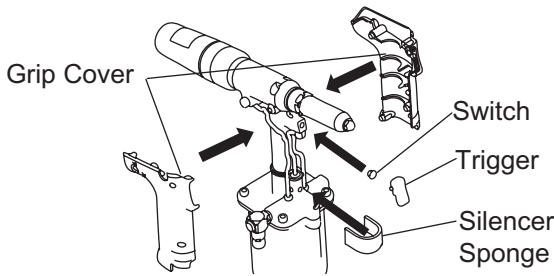

6 Cleaning the Mandrel Shutter section

- Note**
- If the Mandrel Shutter is clogged with cut swarf, the mandrel cannot be discharged.

⚠ CAUTION

- **Before starting maintenance or disassembling the unit to replace parts, be sure to stop air supply.**
Performing maintenance or disassembly with air supplied may cause a part to jump out, oil to squirt out, or the unit to perform unexpected behavior, and may result in an accident or personal injury.
- **Avoid skin contact with substances such as hydraulic oil, lubricating oil and grease.**
Such substances may cause inflammation of the skin. If they come into contact with your skin, wash the affected area thoroughly.

1 Turn off the air supply.

2 Remove the Tank Case Unit by turning it in a counterclockwise direction.

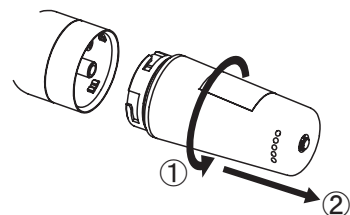

DISASSEMBLY

3 Remove two hex socket bolts in the Tank Joint by using a hex key wrench (AF 2.5mm).

4 Remove the Tank Joint, Outer shaft of frame cap, Helical torsion spring of shutter, Shutter Unit, Shutter Lever in this sequence.

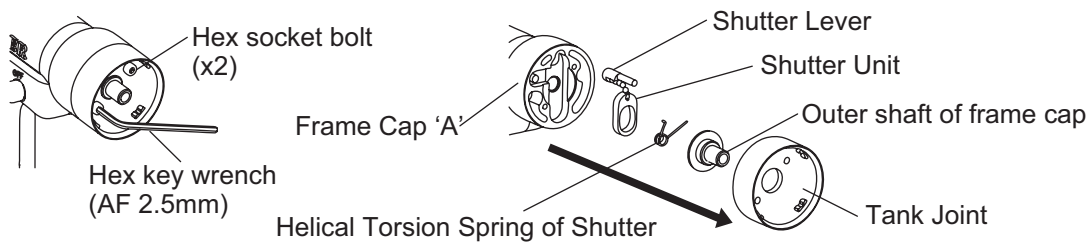

CLEANING

5 Clean each part using a wast cloth and brush.



6 Apply grease to sliding part of Frame Cap 'A'.

- Note**
- Recommended grease is Grease grade 1~2.
 - Apply one drop of grease. If applied ample amounts, it may cause swarf to be clogged to the Mandrel Shutter.

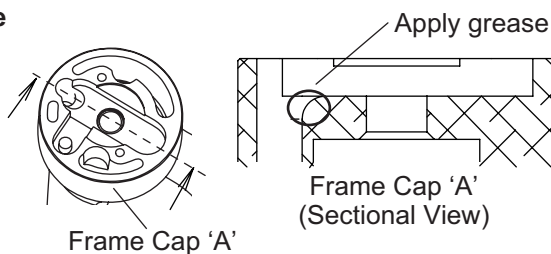

7 Attach the parts to the Frame Cap 'A' by following the sequence of **4** in reverse.

- Note**
- With the Ball Chain attached to the Shutter Lever, push the Shutter Lever into the mounting hole.

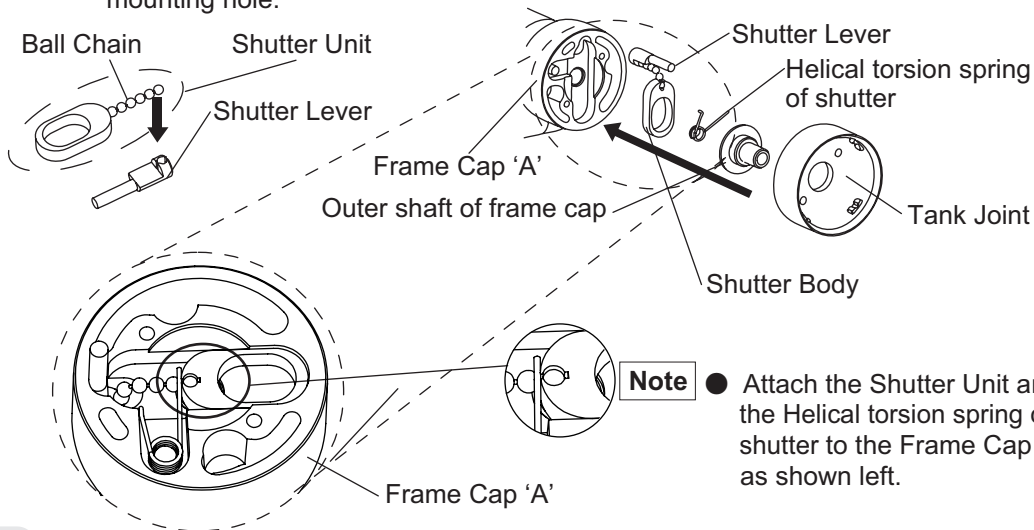

RE-ASSEMBLY

8 Tighten two hex socket bolts in the Tank Joint

- Note**
- Make sure to push down the Shutter Lever and check whether it will come back to original position.

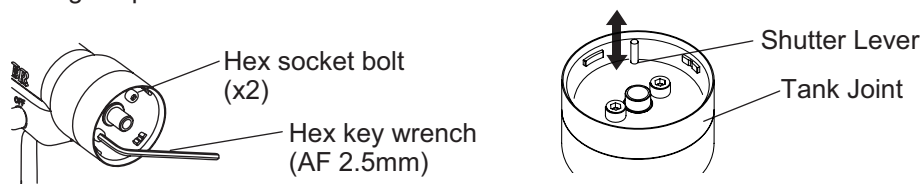

● TROUBLESHOOTING



If a problem occurs, check the followings. If the problem persists after checking the items in the table below, contact your nearest "LOBSTER" dealer or direct to us.

In making any enquiries about this product or requests for repair work, first check the troubleshooting items below, and then make a note of the model number, the usage conditions and the trouble symptoms in as much detail as possible. If you can provide this kind of information, it will contribute to reducing the amount of time required for delivery or repairs to be completed.

Trouble	Cause	Countermeasure
The rivet does not go in, or the cut mandrel does not come out after riveting.	1 Wrong type of Nosepiece or Guide Tube.	Replace with the correct part which matches the rivet size. (Refer to pages 7 and 10.)
	2 Nosepiece or Frame Head 'CJM' is loose.	Use a spanner or similar to tighten securely.
	3 Jaw Case is incorrectly assembled.	Check the assembly procedure of parts inside the Jaw Case. (Refer to page 9.)
	4 Contact surface between Jaws and Jaw Case 'Head' are not smooth. (friction).	Clean the Jaws and the inside of Jaw Case Head, and apply "LOBSTER" brand lubricant oil to the back of Jaws. (Refer to page 9.)
	5 The inside of the Cylinder Cup is dirty so that the Air Piston cannot return to its proper position.	Clean inside the Cylinder Cup, and apply grease inside the cylinder and to the O-ring. (Refer to pages 11 and 12.)
	6 Oil filling was not performed correctly, so that there is excess hydraulic oil inside the tool.	Loosen the Bleed Plug to allow the excess hydraulic oil to drain out. (Refer to pages 11 and 12.)
	7 Mandrels clog up the Jaw Pusher or the Guide Tube.	Eliminate the mandrels clogging in the Jaw Case or the Guide Tube. (Refer to page 9.)
Number of triggers operations increases before riveting is complete. Rivet can not be pulled.	1 The rivet length is not correct for the workpiece thickness.	Use rivet which match the workpiece thickness.
	2 Compressor air pressure is incorrect.	Check the air pressure.
	3 Jaw Case is incorrectly assembled.	Check the assembly procedure of parts inside the Jaw Case. (Refer to page 9.)
	4 Jaws are worn.	Replace the Jaws. (Refer to page 9.)
	5 Insufficient hydraulic oil, causing a shorter stroke.	Add hydraulic oil. (Refer to pages 11 and 12.)
Piston does not operate, or returns very slowly, or operation is not smooth.	1 Insufficient and excess pressure of supplied air.	Adjust to obtain an appropriate pressure of supplied air. (Refer to page 6.)
	2 Malfunction of Air Piston due to dirt or oil shortage inside the Cylinder Cup.	Clean inside the Cylinder Cup and apply grease to the inner surface and the O-ring. (Refer to pages 11 and 12.)
The suction power is weak and the cut mandrels (shafts) cannot be drawn out.	1 The Vacuum Button is not fully pressed.	Press the Vacuum Button fully from the "ON" side.
	2 Too many cut mandrels in the tank.	Remove the Tank Case Unit and discard the cut mandrels.
	3 Cut mandrels clog in the Guide Tube.	Remove the Guide Tube and discard the cut mandrels. (Refer to page 9.)
	4 The Tank Case Sponge is clogging.	Clean or replace the Tank Case Sponge. (Refer to page 10.)
	5 The Guide Tube is not applicable to the size of rivet used.	Replace with a Guide Tube applicable to the rivet used. Remove the Guide Tube if your rivet size is $\phi 4.0$ or $\phi 4.8$. (Refer to pages 7 and 9.)

EXPLODED VIEW

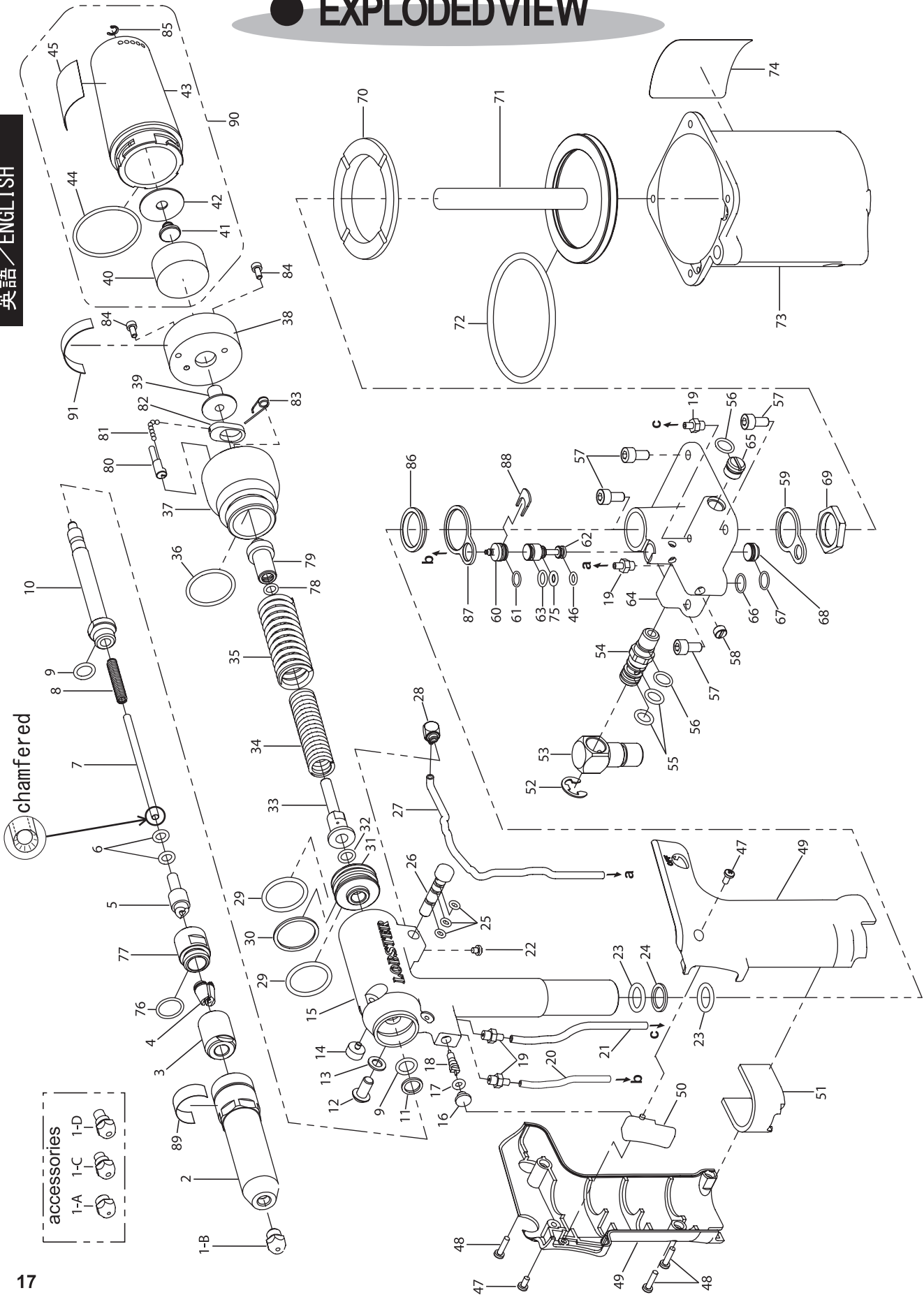

PARTSLIST



Index No.	Part name	Code No.	Material	Index No.	Part name	Code No.	Material
1-A	Nosepiece 2.4 (3/32)	10027	Steel	46	O-ring S5	10276	Rubber
1-B	Nosepiece 3.2 (1/8)	10028	Steel	47	Cross recessed pan head screw M3x6	63250	Steel
1-C	Nosepiece 4.0 (5/32)	10029	Steel	48	Tapping Screw for synthetic resin M3x12	63251	Steel
1-D	Nosepiece 4.8 (3/16)	10030	Steel	49	Grip Cover LR	63263	Plastic
2	Frame Head 'CJM'	64055	Steel	50	Trigger	63227	Plastic
③	Jaw Case Head	10116	Steel	⑤①	Silencer Sponge	63968	Plastic
④	Ultra Jaws (pair) 'M'	10281	Steel	52	E-type Retaining Ring 8	63186	Steel
⑤	Jaw Pusher	63410	Steel	53	Rotary Joint	63184	Aluminum
⑥	O-ring P6	10150	Rubber	54	Spool Connector	63185	Aluminum
⑦	Guide Tube SUS	64875	Stainless	55	O-ring P8	10336	Rubber
⑧	Jaw Pusher Spring	63222	Steel	56	O-ring S9	63180	Rubber
9	O-ring P9	10219	Rubber	57	Hex Socket bolt M5 × 10	64409	Steel
10	Oil Piston 'A'	67631	Steel	58	Stop screw mass production	63245	Plastic
11	B-ring P9	13012	Plastic	59	Air Valve Head Retainer	63183	Steel
12	Bleed plug	63213	Steel	60	Air Valve Head	63979	Stainless
13	Sealing Washer	63209	Rubber	61	O-ring SS7.5	63181	Rubber
14	Vacuum Stop Button	63207	Aluminum	62	Air Valve	63174	Aluminum
15	Frame 'A'	64874	Aluminum	63	O-ring S7	12114	Rubber
16	Switch	63204	Plastic	64	Cylinder Cap 'A'	64873	Aluminum
17	O-ring P4	10454	Rubber	65	Spool Cap	63175	Aluminum
18	Valve Core	63203	①	66	O-ring SS9.5	63969	Rubber
19	Barb Coupling for Soft Tube	43732	Brass	67	O-ring SS9	63182	Rubber
20	Urethane Tube 70	63211	Plastic	68	Valve Cap	63177	Plastic
21	Urethane Tube 87	63210	Plastic	69	Frame Fixing Nut	63228	Steel
22	Cross Recessed Pan Head Screw M3x3	63247	Steel	70	Cushion Rubber	63178	Rubber
23	O-ring P12	10128	Rubber	71	Air Piston Set	63170	③
24	B-ring P12	10129	Plastic	72	O-ring 0670G	63244	Rubber
25	O-ring S4	29664	Rubber	73	Cylinder Cup	63220	Aluminum
26	Vacuum Stop Valve	63205	Aluminum	74	Warning Label	61075	②
27	Urethane Tube 153	63212	Plastic	75	O-ring P5	12120	Rubber
28	Barb Elbow for Soft Tube	63226	Brass	⑦⑥	O-ring S10	10151	Rubber
29	O-ring P22	10180	Rubber	⑦⑦	Jaw Case 'CJM'	64054	Steel
30	B-ring P22	10181	Plastic	78	O-ring S6	10220	Rubber
31	Oil Piston Flange 'A'	67632	Steel	79	Inner shaft of frame cap	64403	Aluminum
32	O-ring P7	10149	Rubber	80	Shutter Lever	64400	Stainless
33	Oil Piston Backward Axis 'A'	64399	Steel	81	Ball Chain	64406	Stainless
34	Return Spring IN	63241	Steel	82	Shutter Body	64401	Stainless
35	Return Spring OUT	63242	Steel	--	Shutter Unit	65057	--
36	O-ring S25	63243	Rubber	83	Helical torsion spring of shutter	64404	Stainless
37	Frame Cap 'A'	64405	Aluminum	84	Hex Socket bolt M3 × 7	64410	Steel
38	Tank Joint	63237	Plastic	85	Crescent type Retaining Ring 21	29187	Steel
39	Outer shaft of frame cap	64402	Steel	86	Bush	64871	Steel
④⑩	Tank Case Sponge	63252	Plastic	87	Air Valve Head Retainer R1A2	63960	Steel
41	Screw for inner surface of tank case	63231	Steel	88	Air Valve Head Rock Plate	63961	Steel
42	Inner surface of tank case	63230	Stainless	89	Frame Head Seal	64598	Plastic
43	Tank Case	63215	Plastic	90	Tank Case Unit	63277	--
44	O-ring S36	63234	Rubber	91	Tank Attaching Seal	67461	②
45	Caution Label	22040	②				

Material ①:Brass,Steel,Plastic,Rubber

Material ②:Paper,Plastic

Material ③:Aluminum,Steel

Note

- Parts with circled Index No. are consumable parts. They should be replaced periodically.
- Index No. 5 includes two Index No. 6.
- Index No. 43 includes Index No. 45.
- Index No. 73 includes Index No. 74.
- Index No. 77 should be attached Index No. 76.
- Index No. 81 (Ball Chain) and Index No. 82 (Shutter Body) will be provided by Shutter Unit (65057)

● STORAGE

- Store in a place which is well-ventilated and free from excessive dust and humidity, and where there is no danger that the tool will fall.
- If not using the tool for an extended period of time, carry out a maintenance inspection before storing it away. (Refer to “Maintenance” on pages 9 ~ 15.)
- To increase the working life of the tool, it is recommended that you give it periodic overhauls. Contact the place of purchase or your nearest “LOBSTER” dealer for any overhauls and repair work required. (A charge will be made for this service.)

HYDRAULIC OIL REQUIREMENTS

Use only clean hydraulic oil, as the viscosity of the oil used will affect tool performance. “LOBSTER” brand Hydraulic Oil is supplied in a plastic filler bottle with the tool, and can also be obtained from your “LOBSTER” dealer or agent in your town. If this is not possible, a good quality mineral oil with the following properties should also be used.

Viscosity ISO : VG46
Viscosity Index : 113
Viscosity at 40 °C : 46 c.s.t.
Viscosity at 100 °C : 7.06 c.s.t.
Flash Point : 228

RECOMMENDED OILS are:
Shell Tellus No. 46
Esso Teresso No. 46
Mobil D.T.E. 25 Oil (Medium)

● ORDERING PARTS

Indicate the tool model, part name, code no. and quantity as shown below when ordering.

Model	Part Name	Code No.	Qty.
R1A1	Ultra Jaws (pair) 'M'	10281	1
R1A1	Frame Head 'CJM'	64055	1

- Note** ● When parts are modified for improvement, the older parts are kept in stock for a period of five years.

WARRANTY & SERVICE

LOBSTER WARRANTS THAT GOODS COVERED BY THIS MANUAL WILL CONFORM TO APPLICABLE SPECIFICATIONS AND DRAWINGS AND THAT SUCH GOODS WILL BE MANUFACTURED AND INSPECTED ACCORDING TO GENERALLY ACCEPTED PRACTICES OF COMPANIES MANUFACTURING INDUSTRIAL TOOLS. THERE ARE NO WARRANTIES WHICH EXTEND BEYOND THE FOREGOING.

THE LIABILITY OF LOBSTER ON PARTS FOUND TO BE DEFECTIVE IS LIMITED TO RE-WORK OR THE REPLACEMENT OF SUCH GOODS AND IN NO CASE TO EXCEED THE INVOICE VALUE OF THE SAID GOODS. UNDER NO CIRCUMSTANCES WILL LOBSTER BE LIABLE FOR DAMAGES OR COSTS INCURRED BY THE BUYER OR SUBSEQUENT USER IN REPAIRING OR REPLACING DEFECTIVE GOODS.

ROUTINE MAINTENANCE AND REPAIR OF LOBSTER RIVET TOOLS CAN BE PERFORMED BY AN AVERAGE MECHANIC. HOWEVER, IF YOU HAVE A LOBSTER RIVET TOOL THAT IS IN NEED OF MAJOR REPAIR WE RECOMMEND THAT IT BE SENT DIRECTLY TO US POSTAGE PAID FOR SERVICE AT A REASONABLE CHARGES.

MANUFACTURER

LOBTEX CO.,LTD.

OSAKA, JAPAN

MEMO

英語 / ENGLISH

A series of horizontal dotted lines for writing.