



# AIR RIVETER CE

## INSTRUCTION MANUAL

### AR - 011MX AR - 011HX

#### CONTENTS

INTRODUCTION .....	1
IMPORTANT SAFETY INSTRUCTIONS .....	2
NOMENCLATURE .....	5
TECHNICAL DATA .....	6
PREPARATION BEFORE USE .....	7
OPERATING THE AIR RIVETER .....	9
MAINTENANCE .....	10
STORAGE .....	12
ORDERING PARTS .....	13
TROUBLESHOOTING .....	13
PARTS TABLE OF AR-011MX ..	15
PARTS TABLE OF AR-011HX ..	17

英語 / ENGLISH



Professional model of air riveter to install blind rivets.

- Thank you very much for purchasing “LOBSTER” air riveter. To ensure correct operation, please read this instruction manual carefully, and keep it in a safe place for later reference.
- This instruction manual contains information for models AR-011MX and AR-011HX. Be sure to refer to information that is applicable to the model you are using.
- This is Original instructions. (Original Instruction Manual is written in English language.)

MANUFACTURER

**LOBTEX CO.,LTD.**

International Marketing & Sales Division

12-8 Shijo-cho, Higashi Osaka City

Osaka 579-8053, Japan

Telephone : +81(72)981-7466

Telefacs : +81(72)981-9420

URL <http://www.lobtex.co.jp/>

PRINTED IN JAPAN

# ●INTRODUCTION

- Thank you very much for purchasing “LOBSTER” air riveter.
- ◎ These are the blind rivet tools which is only used for fixing blind rivets.  
These tools are not designed for other purposes.
- ◎ This instruction manual shows how to use the tools safety, work properly, maintenance and inspection which will make tools more effectively.
- ◎ Please check the blind rivets specification and durability on customers side before using it.

## 1 IMPORTANT NOTICES

- Please read this instruction manual carefully before using the tools. Also, please follow the instructions in the manual when changing the parts.
- Please contact your nearest Lobtex distributor if there was unclear point about the tools.
- It is impossible to define every risk by using the tools and show in this instruction manual.  
Please be sure to use the tools in safe condition besides what is indicated in this instruction manual.
- The copyright of this instruction manual is owned by Lobtex Co., Ltd. It is forbidden to release, copy or translate to other language without permissions.

## 2 EXCLUSION OF LIABILITY

- We do not recompense any failure caused either directly or indirectly and will not recompense blind rivet such like the durability of the blind rivet.
- We do not recompense any failure caused by remodel the tools without any agreement by documents.
- We do not recompense any failure which was caused by using the spare parts which is not recommended.

# ● IMPORTANT SAFETY INSTRUCTIONS



- ◆ Be sure to read following IMPORTANT SAFETY INSTRUCTIONS carefully and make sure that you understand them thoroughly before using this tool.



- ◆ Always wear eye-protection at all times during use. If this is not observed, the cut mandrels may eject out when the blind rivets are cut and cause serious injury.



- ◆ This is the safety alert symbol. It is used to alert you to potential personal injury hazards. Obey all safety messages that follow this symbol to avoid possible injury or death.

- ◆ The IMPORTANT SAFETY INSTRUCTIONS are divided into **⚠ WARNING** and **⚠ CAUTION**. The differences between these two levels are described below.

**⚠ WARNING** : Indicates a potentially hazardous situation which, if not avoided, could result in death or serious injury to the operator.

**⚠ CAUTION** : Indicates a potentially hazardous situation which, if not avoided, may result in moderate injury to the operator or physical damage.

Moreover, failure to follow the instructions marked with the **⚠ CAUTION** symbol or cautions without a **⚠ CAUTION** symbol which appear in the text of this manual may also have serious results in some cases. Always be sure to observe the instructions given in the Important Safety Instructions.

- ◆ After reading this instruction manual, keep it in a safe place where it is easily accessible to tool users.

## **⚠ WARNING**

### **1. The air pressure should be kept within the range of 0.5 to 0.6 MPa.**

- If an air pressure which is greater than this is used, the tool may become damaged, and injury or damage to property may result.

### **2. Never look into the Nosepiece of the tool, and never point the Nosepiece toward other persons.**

- If the tool is used while the cut mandrels are still inside the tool not being ejected, these mandrels may be ejected from the tool's Nosepiece during use and cause serious injury.

### **3. Always attach the Safety Cap before use.**

- If this is not observed, the spent mandrel may be ejected when the blind rivets are cut and cause serious injury.

### **4. Wear protective glasses during use.**

- Failure to do so may result in an accident or personal injury in case that a blind rivet or a piece of spent mandrel jumps out toward you from the tool's Nosepiece or Safety Cap.

### **5. Make sure that the tool and the air source are connected securely.**

- If the threads of the joints do not match or if the screws are not inserted far enough, the air hose may become disconnected during use and injury may result.
- Use hose bands to securely connect the Air Hose Joint and air hose. If they are not connected securely enough, the air hose may become disconnected during use and injury may result.

 **WARNING**
**6. Turn off the air supply before disconnecting the tool from the air source.**

- Compressed air may cause the air hose to whip around, and injury may result.

**7. Check that all the tool parts are free from damage before use. Any damaged parts should be repaired before the tool is used.**

- If the tool is used while any parts are still damaged, injury may result.
- If the tool is damaged by objects being dropped onto it, for instance, the damaged part may break and accident or injury may result.
- Don't pull and drag the tool by the air hose. It may trigger some damages on the tool body, breakage of Rotary Joint or some other defects and lead serious troubles with injuries.

**8. If using in elevated locations, use a safety harness, and take care to avoid dropping blind rivets or the tool itself.**

- Accident or injury may result if this practice is not followed.

 **CAUTION**
**1. Before starting maintenance or disassembling the unit to replace parts, be sure to turn off the air supply.**

- Performing maintenance or disassembly with air supplied may cause a part to jump out, oil to squirt out, or the unit to perform unexpected behavior, and may result in an accident or personal injury.

**2. Do not operate the tool with the Frame Head removed.**

- Items such as fingers may become caught in the mechanism.

**3. Do not bring your face close to the air outlet holes.**

- Pressurized air containing fine particles is discharged from the air outlet holes during use. Keep eyes away from this area.

**4. Avoid skin contact with substances such as hydraulic oil, lubricating oil and grease.**

- Such substances may cause inflammation of the skin. If they come into contact with your skin, wash the affected area thoroughly.

**5. The parts to be used must be those supplied from us or recommended by us. Select and attach parts applicable to your blind rivet.**

- Otherwise the unit may not produce maximum performance and may sometimes malfunction resulting in an accident or personal injury.

**6. Make sure that the workplace is safe, clean and organized.**

- Accidents can easily occur in untidy workplace.
- If the cut-mandrels are allowed to fall onto the floor, you may slip on them, and injury may result.

**7. Avoid uncomfortable postures while working.**

- You may fall down and injury may result.

**8. Keep people who are not involved in work away from the workplace.**

- Accidents or injury may result.

**9. Maintain the tool with due care.**

- Refer to the Instruction Manual for details on replacing parts and attachments, otherwise injury may occur.



**10. Keep the handgrip always dry and clean, and avoid adhesion of oil and grease.**

- Otherwise the grip may slip from your hand resulting in falling of the unit.

**11. Do not leave the floor littered with cut – mandrels.**

- Cut-mandrels are dangerous because their ends are sharp. Stepping on them is also dangerous easily causing a slip and fall accident.

**12. Use the tool carefully and concentrate on correct operation at all times.**

- Use the tool with proper care, paying full attention to methods of handling and operation and surrounding conditions. Accidents and injury may result if this practice is not followed.
- Use common sense at all times, otherwise accidents or injury may result.
- When you are tired, do not use the tool, otherwise accidents or injury may result.

**13. Ask Lobtex to carry out any repair work required.**

- Repair work should only be carried out by a qualified technician. Please contact your nearest “LOBSTER” distributor, representative, or direct to Lobtex Co., Ltd., Osaka.

If the tool is repaired by someone without the necessary qualifications and experience, the tool may not perform to optimum standards, and accidents or injury may result.

**14. Do not attempt to modify the tool.**

- Unauthorized modifications may cause malfunctions which can lead to accidents or injury.

**15. The year and month of manufacture of the tool are indicated by a code and four – digit number on the Cylinder Cap. (Refer to page 6)**

**16. Warning Labels include important information and tips on using the tool.**

**If the Labels become so dirty or damaged that they cannot be read, order and replace them with new Labels.**

**You can order new Labels from Lobtex Co., Ltd. through our dealers.**

**17. Only for EU countries, do not dispose of electric tools together with household waste material !**

- In observance of European Directive 2002/96/EC on waste electrical and electronic equipment and its implementation in accordance with national law, electric tools that have reached the end of their life must be collected separately and returned to an environmentally compatible recycling facility.

**18. When you handle oil or grease, obtain the material safety data sheet (SDS) and follow the described instructions.**

# ● NOMENCLATURE

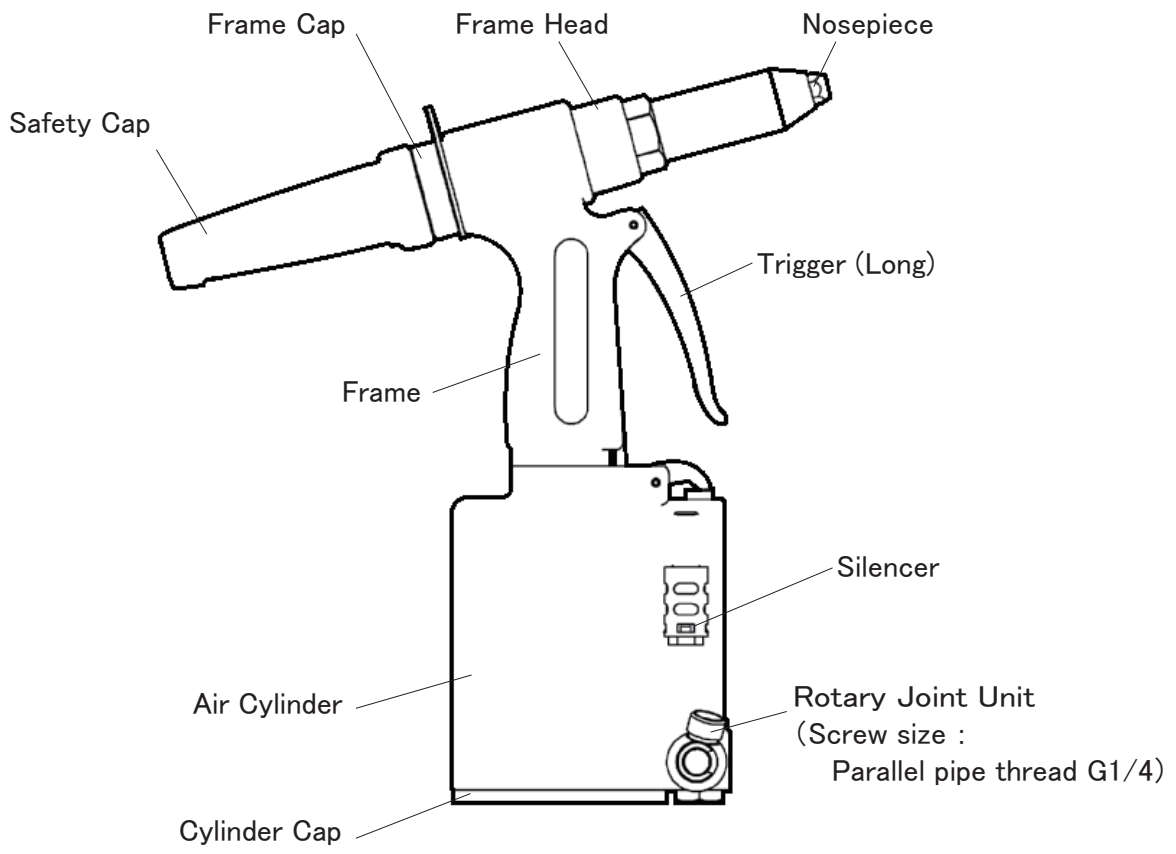

## FRAME HEAD INTERNAL PARTS

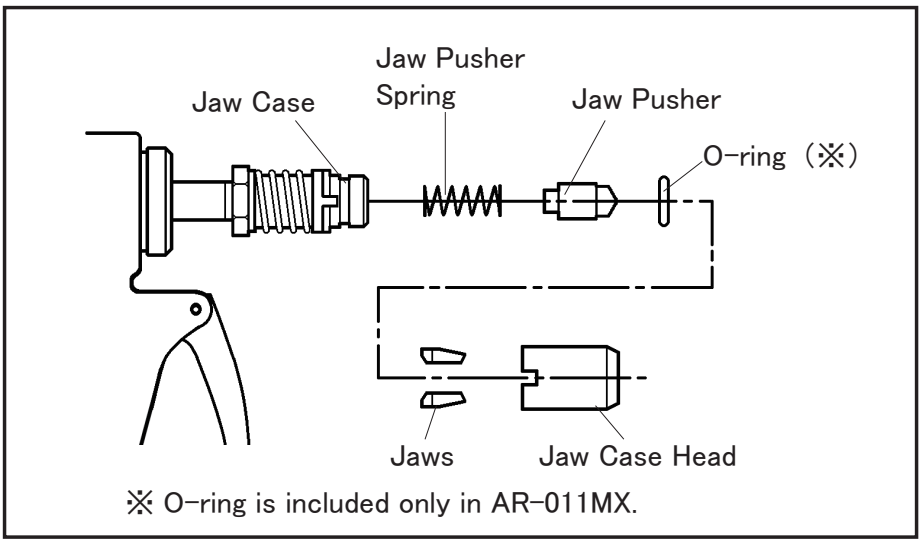

# ● TECHNICAL DATA

Model No.		AR - 011MX	AR - 011HX
Weight	kg	1.5	2.1
Operating air pressure	MPa	0.5~0.6	
Dimensions (Length × Height × Width)	mm	251 × 271 × 80	272 × 312 × 90
Air consumption per blind rivet at 0.6MPa	ℓ	1.8	2.4
Tool stroke	mm	16	16.5
Traction power at 0.6 MPa	kN	9	14
Applicable blind rivets (Rivet diameters)	φ mm	2.4, 3.2, 4.0, 4.8	2.4, 3.2, 4.0, 4.8, 6.4
	φ inch	3/32, 1/8, 5/32, 3/16	3/32, 1/8, 5/32, 3/16, 1/4
Operating environment	Temperature °C (°F)	4~35 (39.2~95)	
	Relative humidity % RH max.	80 (no condensation)	
Sound	dB	75	
Vibration (Emission value)	m/sec <sup>2</sup>	Less than 2.5	
Air intake (Size of screw)		G1/4	

※ Product specifications and design are subject to change for improvement without notice.

※ Weight and dimensions given are standard values. Actual products may differ slightly from the values given.

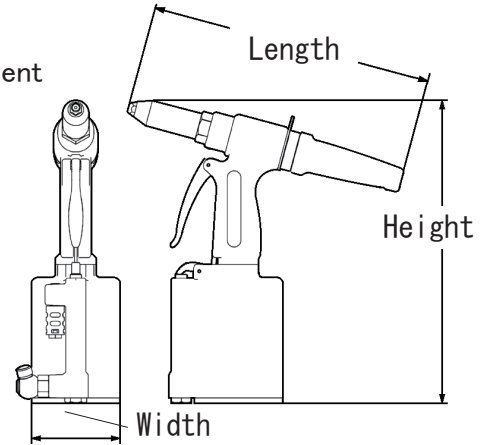

## ■ Air consumption calculation method

Use the following calculation method to obtain the required air consumption, and select the compressor accordingly.

**Required air consumption = Air consumption per blind rivet × No. of rivets per minute**

Make sure that this corresponds to the compressor discharge capacity (per minute).

Manufacturing year of unit	➡	Indicated on the bottom of Air Cylinder in cipher
Installation site of rated plate	➡	Along the side of Air Cylinder
Installation site of caution plate	➡	Along the side of Air Cylinder

※ Rated plate and caution plate is identical.

How to read the year and month of manufacture

A year/month of manufacture	1	2	3	4	5	6	7	8	9	10	11	12
An English character	A	B	M	N	K	W	T	Y	U	O	L	Z

Example

year : 2 0 1 ④ month : 8 → NYOOOO  
                   ↓                  ↓  
                   N                  Y

Revision month of instruction manual
Item : Air rivetter
Model : AR-011MX , AR-011HX
Month of sixth edition : July, 2017

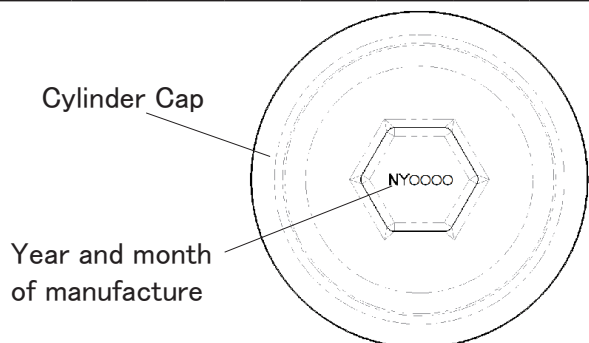

# ● PREPARATION BEFORE USE

## 1 Install the Safety Cap to the tool.

**⚠ WARNING 3 (P. 2)**

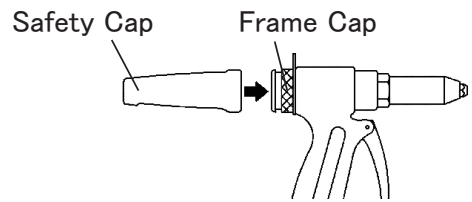

## 2 Set up the compressor, and be sure to install an air filter, air regulator and air lubricator (3- device set) between the compressor and the tool.

※ Adjust the drip-feed amount of the air lubricator to the minimum setting.

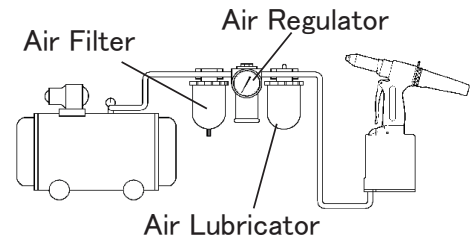

### ATTENTION

If moisture enters inside of the unit, it may freeze in cold temperature or accelerate degradation of O-rings and packings, resulting in malfunction of the unit. To avoid that, use an air dryer as necessary in addition to an air filter, regulator and an air lubricator (3-device set).

## 3 Use the air regulator to adjust the operating air pressure to 0.5 ~ 0.6 MPa.

**⚠ WARNING 1 (P. 2)**

### ATTENTION

If the air pressure is too high, damage to parts may occur. If the pressure is too low, some size of the blind rivet may not be correctly installed (cut).

## 4 Replace the parts to conform to the size of the blind rivet being used.

※ The blind rivet size indicates the diameter of the rivet.

**⚠ CAUTION 6 (P. 3)**

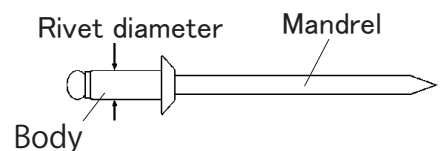

### AR - 0 1 1 M X











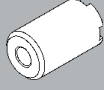
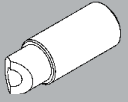

- ◎ At the time of purchase, the tool is fitted with a 3.2mm (1/8") Nosepiece.
- ◎ Different-sized blind rivets can be used just by replacing the Nosepiece.
- ◎ If you wish to use other sizes, use a spanner to remove and replace the Nosepiece.

### AR - 0 1 1 H X

- ◎ At the time of purchase, the tool is fitted with a 4.8mm (3/16") Nosepiece.
- ◎ 2.4mm (3/32"), 3.2mm (1/8") and 4.0mm (5/32") blind rivets can be used just by replacing the Nosepiece.
- ◎ The tool is available to install 6.4mm (1/4") blind rivets subject to conversion of Jaws, Jaw Case Head, Jaw Pusher and Nosepiece. (Refer to page 10 and 11)

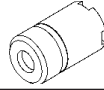
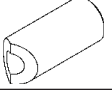

< Table of combinations of replacement parts >

Blind Rivet Dia.	AR - 011MX	AR - 011HX			
	Nosepiece	Nosepiece (Hole dia.)	Ultra Jaws	Jaw Case Head	Jaw Pusher
2.4mm (3/32")	2.4 	2.4 (1.8 mm) 	"M" 	"M" 	"M" 
3.2mm (1/8")	3.2 	3.2 (2.3 mm) 			
4.0mm (5/32")	4.0 	4.0 (2.9 mm) 			
4.8mm (3/16")	4.8 	4.8 (3.3 mm) 			
6.4mm (1/4")		6.4 (4.3 mm) 	"H" 	"H" 	"H" 

 Shaded areas indicate parts which are installed in the tool as standard accessories.

**5** Please change either straight joint or rotary joint by using spanner or similar tools which are suitable for your working environment.

< Table of combinations of replacement parts >

Type of joint	Fitting to A	Fitting to B
Straight joint	Nipple Unit	Change Plug Unit
Rotary joint	End Plug Unit	Rotary Joint Unit

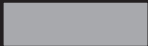
 Shaded areas indicate parts which are installed in the tool as standard accessories.

Screw size of the air intake of straight joint or rotary joint is parallel pipe thread G1/4.

Parts of straight joint are option. (Refer to page 13.)

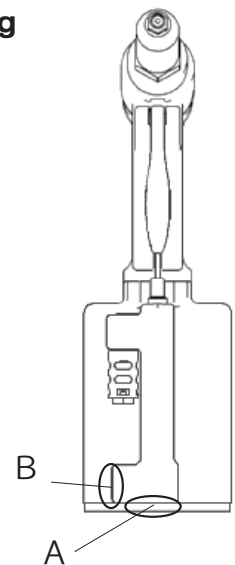

# ● OPERATING THE AIR RIVETER

**1** Select a suitable size of blind rivet for the workpiece to be riveted.

**2** Replace the Nosepiece with one which matches the size of blind rivet to be used.

(Refer to item **4** in “PREPARATION BEFORE USE” on Page. 7 and 8)

**3** Drill a hole of appropriate size (0.1 to 0.2 mm larger than the diameter of the rivet) into the workpiece.

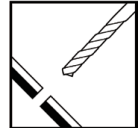

**4** Insert the body of the blind rivet into the hole.

### ATTENTION

Some blind rivets have mandrels with sharp ends.  
Be careful not to injure your fingers on these ends.

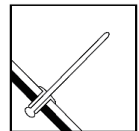

**5** Place the Nosepiece of the air riveter over the mandrel of the blind rivet.

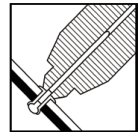

**6** Gently press the Nosepiece of the air riveter against the workpiece. After checking that there is no gap between the Nosepiece and the workpiece, pull the Trigger.

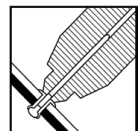

**7** The blind rivet will be installed into the workpiece.

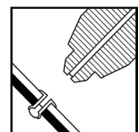

**8** Release the Trigger, and then tilt the air riveter to remove the cut mandrel from the Nosepiece or Safety Cap.

**NOTE :** Make sure that the cut mandrel has been completely removed before proceeding to the next riveting.

### <Operating temperature>

The ambient temperature for working is within the range of 4 ~ 35°C (39.2 ~ 95°F).

# ● MAINTENANCE

After long periods of use, debris from mandrel and other foreign materials tend to build up in various parts of the tool, and the hydraulic oil level also drops, both of which can lead to operating problems. The tool should be cleaned periodically.

**⚠ WARNING** In case you have some trouble and failure, please refer “TROUBLESHOOTING” in this Instruction Manual.

## 1 Jaw maintenance Also refer to this section when replacing parts.

- ⊙ If debris builds up, the jaws will not move smoothly and normal operation will not be possible.
- ⊙ The jaws should be cleaned on average once every 3,000 riveting operations.

DISASSEMBLY

**1** Turn off the air supply. ⚠ CAUTION 1 (P. 3)

**2** Use a Spanner A or similar tool to remove the Frame Head. ⚠ CAUTION 2 (P. 3)

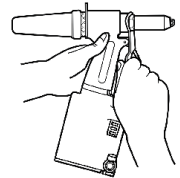

**3** Pull backwards the Jaw Case Collar to loosen and remove the Jaw Case Head, and then remove the Jaw Pusher Spring, Jaw Pusher and Jaws.

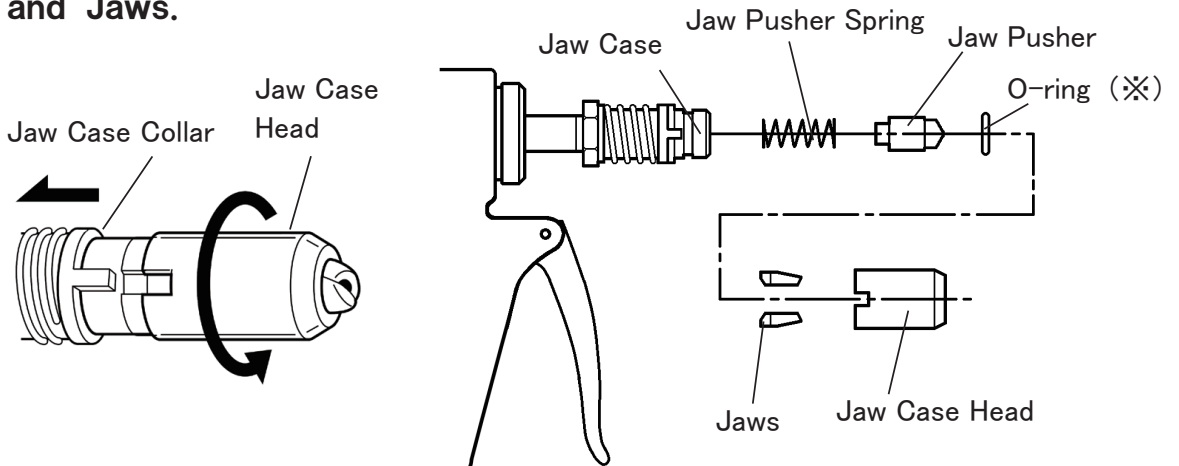

CLEANING

**4** Wash and clean the parts using a brush and kerosene or such other things.

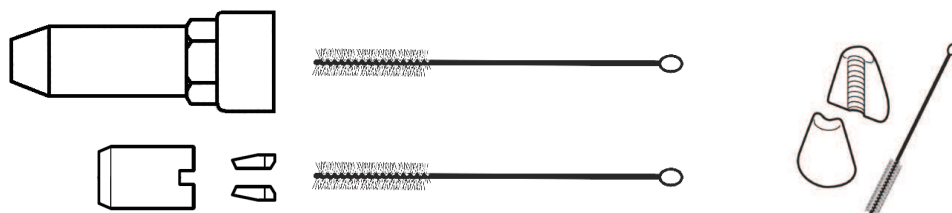

**5** Reassemble by following the disassembly procedure in reverse. Tighten the Jaw Case Head fully, and then turn it back so that the notch is aligned with the tab on the Jaw Case Collar, and move the collar into place.

**NOTE :**  
 ■ Apply LOBSTER Lubricant Oil JO-50 (separately sold : ISO VG150 containing molybdenum disulfide) to the back of the Jaws.  
 The lubricant oil should be applied on average once every 1,000 riveting operations.

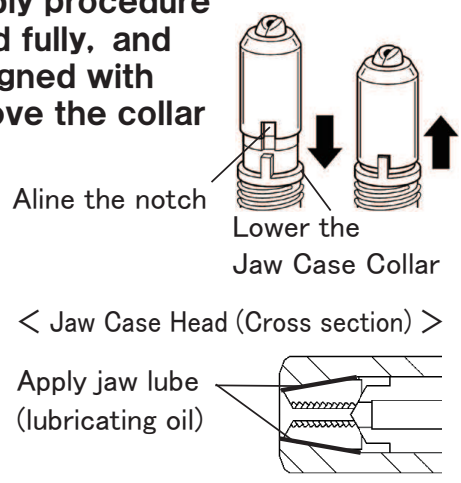

**6** Use a Spanner A or similar tool to install the Frame Head securely.  
**NOTE :**

■ When reassemble, be sure to apply a lubricant such as grease to all moving and sliding parts.  
 ■ Be careful not to leave out any parts, and tighten all connections securely.  
 ■ The Jaws are consumable parts, and they should be replaced periodically.  
 ■ The Jaw Case and Jaw Case Lock Nut do not need to be removed during maintenance.  
 If they are removed by mistake, replace them so that the distance matches those shown in the illustration at right by using a spanner or similar tool and the Spanner B.

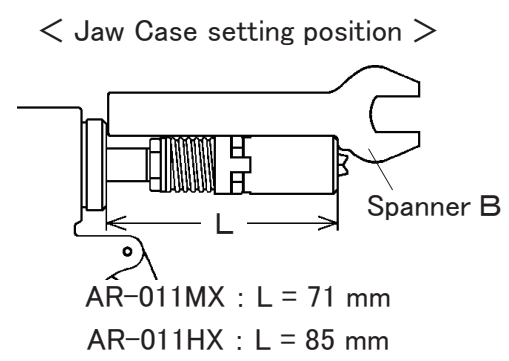

**2** Cleaning and filing the Air Cylinder

⊙ If foreign materials build up in the Air Cylinder, it will not operate smoothly and service life will be reduced.  
 ⊙ Be sure to remove the Frame Head when adding hydraulic oil. And then, check the setting position of Jaw Case Head.  
 Excess oil pushes the Oil Piston downward too much, then, the damage of the O-ring and the B-ring may result.

**1** Turn off the air supply. **⚠ CAUTION 1 (P. 3)**

**2** Use a Spanner A or similar tool to remove the Frame Head. **⚠ CAUTION 2 (P. 3)**

**3** Use a Spanner A or similar tool to remove the Cylinder Cap and pull - out the Air Piston straightly using suitable pliers.

**NOTE :**  
 ■ Hold the Air Cylinder vertical, as the hydraulic oil will spill out if it is tipped sideways.

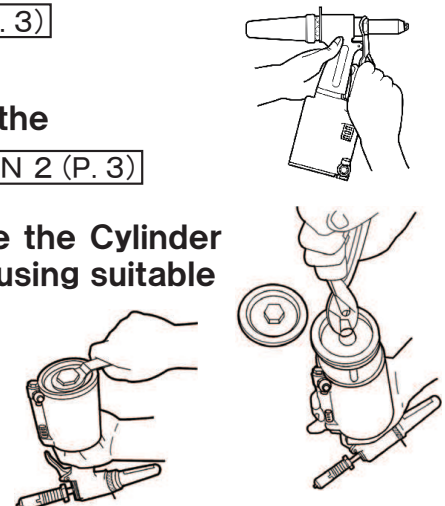

**4** Use a rag, brush or similar to clean all parts.

**5** Supply LOBSTER Hydraulic Oil (UO-100) (separately sold) to the oil supply port of the Air Cylinder until the oil slightly over the O-ring and the B-ring.

※ Hydraulic oil used (viscosity)  
---ISO VG 46.

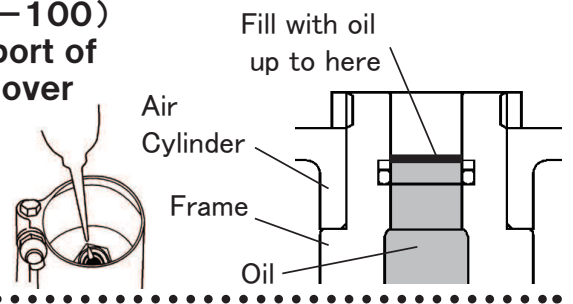

**6** After apply grease on the O-ring and rod of Air Piston Unit and on the inside of Air Cylinder, reassemble by following the reverse procedure to disassemble.

**NOTE :**

- Before assembling, be sure to apply lubricant such as grease to each sliding section.
- Recommended grease is Grease grade 1 ~ 2.

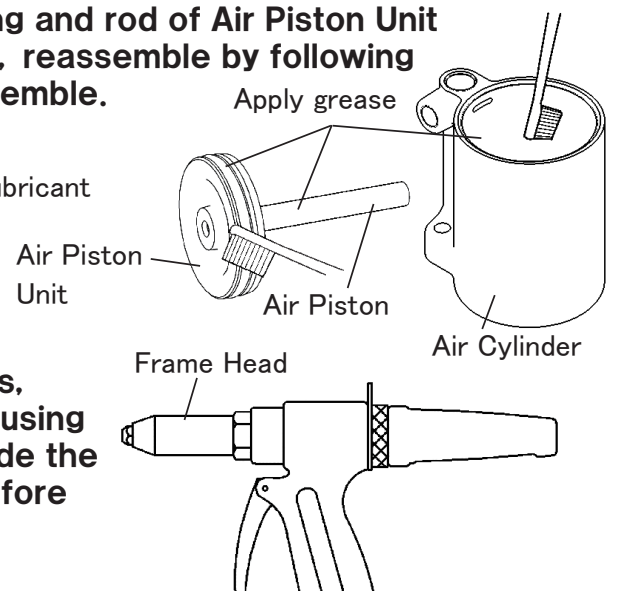

**7** After reassembled all other parts, install the Frame Head securely using a spanner A. Wipe any oil outside the tool and clean up any spilt oil before using the tool.

## ● STORAGE

- Store in a place which is well-ventilated and free from excessive dust and humidity, and where there is no danger that the tool will fall.
- If not using the tool for an extended period of time, carry out a maintenance inspection before storing it away. (Refer to "MAINTENANCE" on pages 10 ~ 12.)
- To increase the working life of the tool, it is recommended that you give it periodic overhauls. Contact the place of purchase or your nearest "LOBSTER" dealer for any overhauls and repair work required. (A charge will be made for this service.)

HYDRAULIC OIL REQUIERMENTS	
Use only clean hydraulic oil, as the viscosity of the oil used will affect tool performance.	
"LOBSTER" brand Hydraulic Oil is supplied in a plastic filler bottle with the tool, and can also be obtained from your "LOBSTER" dealer or agent in your town. If this is not possible, a good quality mineral oil with the following properties should also be used.	

Viscosity ISO	VG46
Viscosity Index	113
Viscosity at 40°C	46 c.s.t.
Viscosity at 100°C	7.06 c.s.t
Flash Point	228

RECOMMENDED OILS are:  
Shell Tellus No.46  
Esso Teresso No.46  
Mobil D.T.E. 25 Oil (Medium)

## ● ORDERING PARTS

Indicate the tool model, part name, code no. and quantity as shown below when ordering.

Model	Part Name	Code No.	Qty.
AR-011MX	Ultra Jaws (pair) 'M'	10281	1 pair
AR-011MX	Frame Head	10105	1 pc

※ When parts are modified for improvement, the older parts are kept in stock for a period of five years.

We offer the following parts as parts sold separately.

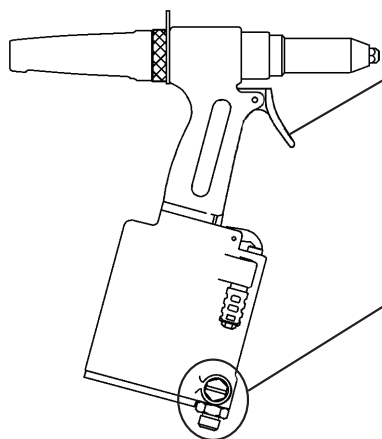

Trigger (Short)

Model	Part Name	Code No.
AR-011MX	Trigger (Short) Unit "M"	10021
AR-011HX	Trigger (Short) Unit "H"	14538

Straight joint parts

Model	Part Name	Code No.
AR-011MX or AR-011HX	Change Plug Unit	42509
	Nipple Unit	65191

## ● TROUBLESHOOTING

If a problem occurs, check the followings.

If the problem persists after checking the items in the table below, contact your nearest "LOBSTER" dealer or direct to us.

**In making any enquiries about this product or requests for repair work, first check the troubleshooting items below, and then make a note of the model number, the usage conditions and the trouble symptoms in as much detail as possible. If you can provide this kind of information, it will contribute to reducing the amount of time required for delivery or repairs to be completed.**

Trouble		Cause	Countermeasure
<b>The blind rivet does not go in, or the cut mandrel does not come out after rivetting.</b>	1	Lubricant oil shortage of the contact surface between Jaws and Jaw Case Head.	Apply "LOBSTER" brand Lubricant Oil to the back of Jaws. (Refer to page 10 and 11.)
	2	Contact surface between Jaws and Jaw Case Head are not smooth. (friction).	Clean the Jaws and the inside of Jaw Case Head, and apply "LOBSTER" brand Lubricant Oil to the back of Jaws. (Refer to page 10 and 11.)
	3	Wrong type of parts.	Replace with the correct part which matches the blind rivet size. (Refer to page 7 and 8.)
	4	Nosepiece or Frame Head is loose.	Use a Spanner A or similar to tighten securely.
	5	Jaw Case is incorrectly assembled. (Setting position is incorrect.)	Check the Jaw Case setting position. (Refer to page 11.)
	6	The inside of the Frame Head is dirty so that the Jaws cannot open property.	Clean the inside of the Frame Head and the Jaws. (Refer to page 10 and 11.)
	7	The tail end of the Nosepiece is damaged so that the Jaws cannot open property.	Replace the Nosepiece.
	8	The inside of the Air Cylinder is dirty so that the Air Piston cannot return to its proper position.	Clean inside the Air Cylinder, and apply grease inside the Air Cylinder and to the O-ring. (Refer to page 11 and 12.)
	9	Oil filling was not performed correctly, so that there is excess hydraulic oil inside the tool.	Refill the hydraulic oil after remove the Frame Head. (Refer to page 11 and 12.)
<b>Number of switch operations increases before rivetting is complete.</b>	1	The blind rivet length is not correct for the workpiece thickness.	Use blind rivet which match the workpiece thickness.
	2	Compressor air pressure is incorrect.	Adjust to obtain an appropriate pressure of supplied air. 0.5 ~ 0.6 MPa
	3	Jaw Case is incorrectly assembled. (Setting position is incorrect.)	Check the Jaw Case setting position. (Refer to page 11.)
	4	Jaws are worn.	Replace the Jaws. (Refer to page 10 and 11.)
	5	Insufficient hydraulic oil, causing a shorter stroke.	Add hydraulic oil. (Refer to page 11 and 12.)
<b>Air Piston does not operate, or returns very slowly, or operations is not smooth.</b>	1	Malfunction of the Air Piston due to dirt or oil shortage inside the Air Cylinder.	Clean inside the Air Cylinder, and apply grease inside the Air Cylinder and to the O-ring. (Refer to page 11 and 12.)
	2	Insufficient and excess pressure of supplied air.	Adjust to obtain an appropriate pressure of supplied air. 0.5 ~ 0.6 MPa

# ●PARTS TABLE OF AR-011 MX

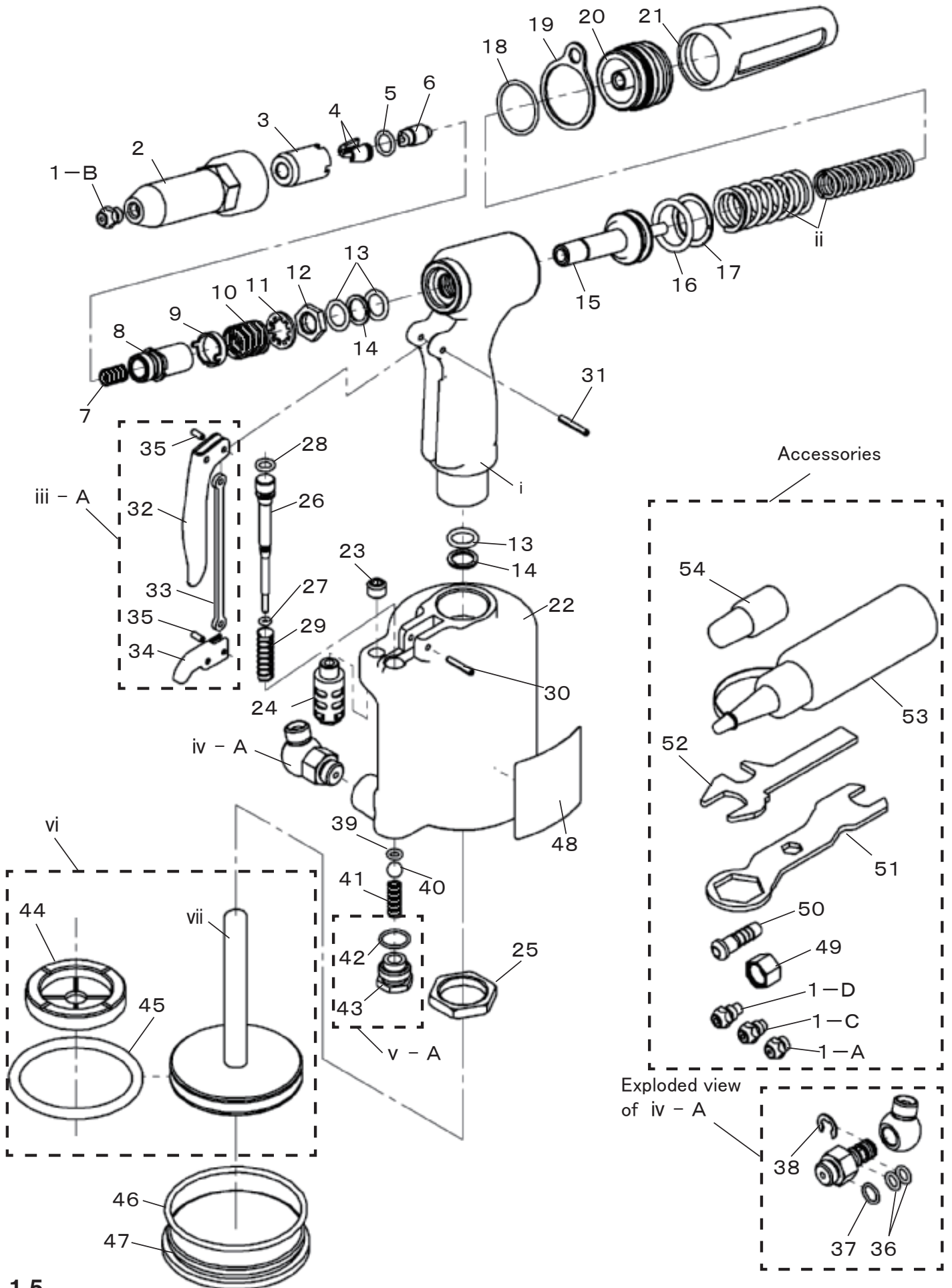



Index No.	Part Name	Code No.	Material	Index No.	Part Name	Code No.	Material
①-A	Nosepiece 2.4 (3/32)	10027	Steel	30	Spring Pin 3 × 18	10145	Steel
①-B	Nosepiece 3.2 (1/8)	10028	Steel	31	Spring Pin 3 × 20	10251	Steel
①-C	Nosepiece 4.0 (5/32)	10029	Steel	iii - A	Trigger (Long) Unit "M"	20510	Steel
①-D	Nosepiece 4.8 (3/16)	10030	Steel	32	Trigger (Long)	13121	Steel
2	Frame Head	10105	Steel	33	Trigger Connector Rod	10120	Steel
③	Jaw Case Head	10280	Steel	34	Trigger Lever	10119	Steel
④	Ultra Jaws (pair) 'M'	10281	Steel	35	Spring Pin 3 × 7.2	23595	Steel
⑤	O-ring P-10	10274	Rubber	iv - A	Rotary Joint Unit	42502	②
⑥	Jaw Pusher	10132	Steel	③⑥	O-ring P-7	10149	Rubber
⑦	Jaw Pusher Spring	10133	Steel	37	O-ring S-10	10151	Rubber
⑧	Jaw Case	10279	Steel	38	Retaining ring E-7	10285	Steel
9	Jaw Case Collar	10286	Steel	③⑨	Valve Packing	66064	Rubber
10	Collar Spring	10287	Steel	40	Valve (Steel Ball 8.0)	10247	Steel
⑪	Lock Washer	10148	Steel	41	Valve Spring	10444	Steel
12	Jaw Case Lock Nut	10113	Steel	v - A	End Plug Unit	65180	③
i	Frame Unit	65193	①	42	O-ring S-14	10152	Rubber
⑬	O-ring P-12	10128	Rubber	43	End Plug	65178	Brass
⑭	B-ring P-12	10129	Plastic	vi	Air Piston Unit	65198	②
15	Oil Piston	10241	Steel	⑦	Air Piston Rod Unit	65199	④
⑯	O-ring P-22A	10130	Rubber	④④	Bumper (Rubber Cushion)	29736	Rubber
⑰	B-ring P-22A	10131	Plastic	④⑤	O-ring P-60	10134	Rubber
ii	Retun Spring	66004	Steel	④⑥	O-ring G-70	10080	Rubber
18	O-ring S-26	10153	Rubber	47	Cylinder Cap	10011	Aluminum
⑲	Hanger Clip	10106	Steel	48	Warning Label	61075	⑤
20	Frame Cap A	66002	Aluminum	49	Air Hose Joint Nut 1/4	10139	Brass
⑳	Safety Cap	42505	Rubber	50	Air Hose Joint 1/4	10140	Brass
22	Air Cylinder	65197	④	51	Spanner 'A'	10141	Steel
23	Plug	14359	Steel	52	Spanner 'B'	10142	Steel
⑳	Silencer	14355	Plastic	⑤③	Hydraulic Oil (in a bottle)	10012	Plastic
25	Frame Lock Nut	10112	Steel	⑤④	Lubricant Oil (in a bottle)	64088	Plastic
26	Valve Pusher	65187	Steel	Option			
⑳	O-ring P-3	10333	Rubber	iii - B	Trigger (Short) Unit 'M'	10021	Steel
⑳	O-ring P-7	10149	Rubber	iv - B	Change Plug Unit	42509	⑥
29	Valve Pusher Spring	12132	Steel	v - B	Nipple Unit	65191	③

※ Parts with circled Index No. are consumable parts. They should be replaced periodically.

※ Index No. i (Frame Unit) includes Index No.13 and 14 (O-ring P-12 and B-ring P-12).

※ Index No.22 (Air Cylinder) includes Index No.23 (Plug).

※ Unit parts materials

- |                             |                           |                   |
|-----------------------------|---------------------------|-------------------|
| ① Aluminum, Rubber, Plastic | ② Aluminum, Rubber, Steel | ③ Brass, Rubber   |
| ④ Aluminum, Steel           | ⑤ Paper, Plastic          | ⑥ Rubber, Plastic |

# ●PARTS TABLE OF AR-011 HX

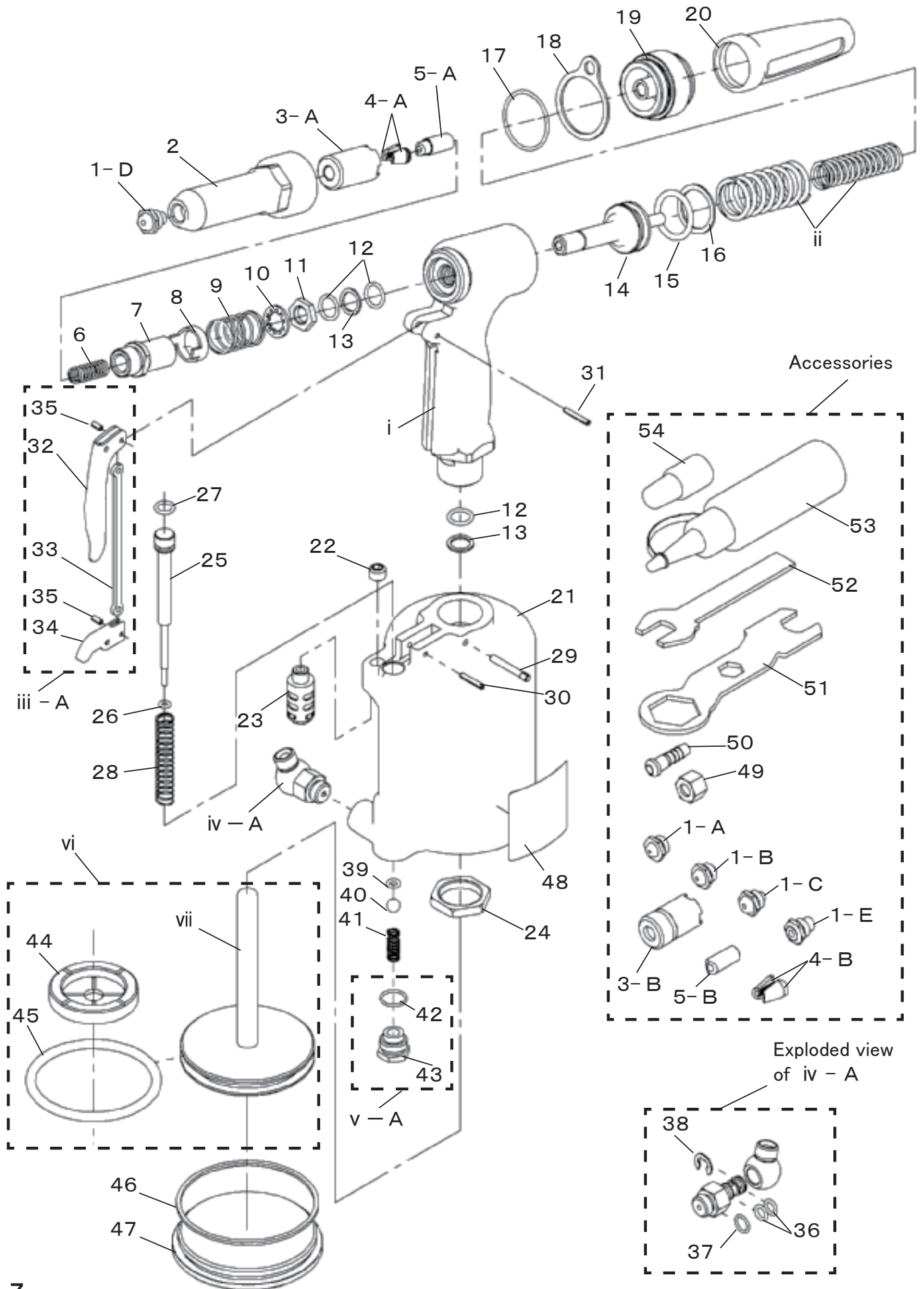

Index No.	Part Name	Code No.	Material	Index No.	Part Name	Code No.	Material
①-A	Nosepiece 'H' 2.4	10213	Steel	28	Valve Pusher Spring	10453	Steel
①-B	Nosepiece 'H' 3.2	10214	Steel	29	Slotted Pin 4 × 31	14154	Steel
①-C	Nosepiece 'H' 4.0	10215	Steel	30	Spring Pin 3 × 18	10145	Steel
①-D	Nosepiece 'H' 4.8	14350	Steel	31	Spring Pin 3 × 20	10251	Steel
①-E	Nosepiece 'H' 6.4	10226	Steel	iii - A	Trigger (Long) Unit 'H'	20512	Steel
2	Frame Head	10191	Steel	32	Trigger (Long)	13126	Steel
③-A	Jaw Case Head 'M'	14378	Steel	33	Trigger Connector Rod	10202	Steel
③-B	Jaw Case Head 'H'	10447	Steel	34	Trigger Lever	10119	Steel
④-A	Ultra Jaws (Pair) 'M'	10281	Steel	35	Spring Pin 3 × 7.2	23595	Steel
④-B	Ultra Jaws (Pair) 'H'	10493	Steel	iv - A	Rotary Joint Unit	42502	②
⑤-A	Jaw Pusher 'M'	10209	Steel	③⑥	O-ring P-7	10149	Rubber
⑤-B	Jaw Pusher 'H'	10224	Steel	37	O-ring S-10	10151	Rubber
⑥	Jaw Pusher Spring	10210	Steel	38	Retaining ring E-7	10285	Steel
⑦	Jaw Case	10429	Steel	③⑨	Valve Packing	66064	Rubber
8	Jaw Case Collar	10448	Steel	40	Valve (Steel Ball 8.0)	10247	Steel
9	Collar Spring	10449	Steel	41	Valve Spring	10444	Steel
⑩	Lock Washer	10148	Steel	v - A	End Plug Unit	65180	③
11	Jaw Case Lock Nut	10113	Steel	42	O-ring S-14	10152	Rubber
i	Frame Unit	65413	①	43	End Plug	65178	Brass
⑫	O-ring P-12	10128	Rubber	vi	Air Piston Unit	65416	②
⑬	B-ring P-12	10129	Plastic	⑦	Air Piston Rod Unit	65417	④
14	Oil Piston	10195	Steel	④④	Bumper (Rubber Cushion)	29736	Rubber
⑮	O-ring P-24	10207	Rubber	④⑤	O-ring P-70	10212	Rubber
⑯	B-ring P-24	10208	Plastic	④⑥	O-ring G-80	10211	Rubber
ii	Return Spring	14139	Steel	47	Cylinder Cap	10059	Aluminum
17	O-ring S-28	10221	Rubber	48	Warning Label	61075	⑤
⑱	Hanger Clip	10192	Steel	49	Air Hose Joint Nut 1/4	10139	Brass
19	Frame Cap	65420	Aluminum	50	Air Hose Joint 1/4	10140	Brass
⑳	Safety Cap	42505	Rubber	51	Spanner 'A'	10217	Steel
21	Air Cylinder	65411	④	52	Spanner 'B'	10218	Steel
22	Plug	14359	Steel	⑤③	Hydraulic Oil	10012	Prastic
⑳	Silencer	14355	Plastic	⑤④	Lubricant Oil (in a bottle)	64088	Prastic
24	Frame Lock Nut	10112	Steel	Option			
25	Valve Pusher	65929	Brass	iii - B	Trigger (Short) Unit 'H'	14538	Steel
⑳	O-ring P-4	10454	Rubber	iv - B	Change Plug Unit	42509	⑥
㉑	O-ring P-9	10219	Rubber	v - B	Nipple Unit	65191	③

※ Parts with circled Index No. are consumable parts. They should be replaced periodically.

※ Index No. i (Frame Unit) includes Index No.12 and 13 (O-ring P-12 and B-ring P-12).

※ Index No.21 (Air Cylinder) includes Index No.22 (Plug).

※ Unit parts materials

- ① Aluminum, Rubber, Plastic      ② Aluminum, Rubber, Steel      ③ Brass, Rubber  
 ④ Aluminum, Steel                  ⑤ Paper, Plastic                  ⑥ Rubber, Plastic

## WARRANTY & SERVICE

LOBSTER<sup>®</sup> WARRANTS THAT GOODS COVERED BY THIS MANUAL WILL CONFORM TO APPLICABLE SPECIFICATIONS AND DRAWINGS AND THAT SUCH GOODS WILL BE MANUFACTURED AND INSPECTED ACCORDING TO GENERALLY ACCEPTED PRACTICES OF COMPANIES MANUFACTURING INDUSTRIAL TOOLS. THERE ARE NO WARRANTIES WHICH EXTEND BEYOND THE FOREGOING.

THE LIABILITY OF LOBSTER<sup>®</sup> ON PARTS FOUND TO BE DEFECTIVE IS LIMITED TO RE-WORK OR THE REPLACEMENT OF SUCH GOODS AND IN NO CASE TO EXCEED THE INVOICE VALUE OF THE SAID GOODS. UNDER NO CIRCUMSTANCES WILL LOBSTER<sup>®</sup> BE LIABLE FOR DAMAGES OR COSTS INCURRED BY THE BUYER OR SUBSEQUENT USER IN REPAIRING OR REPLACING DEFECTIVE GOODS.

ROUTINE MAINTENANCE AND REPAIR OF LOBSTER<sup>®</sup> RIVET TOOLS CAN BE PERFORMED BY AN AVERAGE MECHANIC. HOWEVER, IF YOU HAVE A LOBSTER<sup>®</sup> RIVET TOOL THAT IS IN NEED OF MAJOR REPAIR WE RECOMMEND THAT IT BE SENT DIRECTLY TO US POSTAGE PAID FOR SERVICE AT A REASONABLE CHARGES.

MANUFACTURER

**LOBTEX CO.,LTD.**

OSAKA, JAPAN